



# OUTLINE IP67 TUNABLE WHITE

Outline A002M IEC AGY ECL / TW56/Nx G4 09W 820/857 L1000  
Luminaire segment



## COLORS

Grey housing

## PHOTOMETRICS

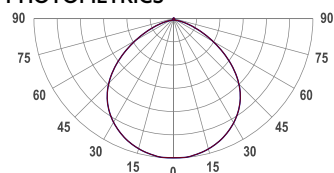

## SEGMENT LAYOUT

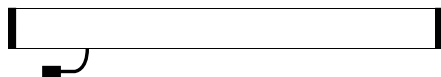

Luminaire type segment

## CONNECTION TYPE

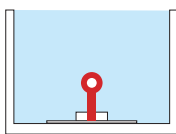

End exit wire

## TECHNICAL DRAWING

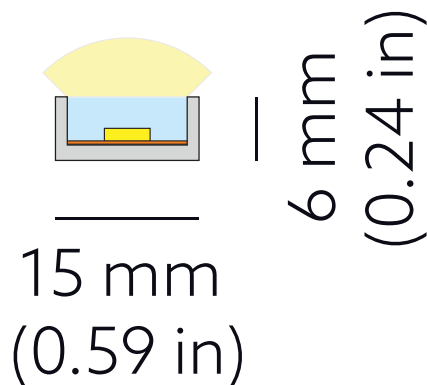

## SPECTRUM

Warm LED: CRI 80+ 2000K

Cold LED: CRI 80+ 5700K

3-Step MacAdam

## COVER

Clear

## LUMINOUS FLUX

Per segment: 783 lm

Light source (per segment): 1255 lm

Per meter/feet: 783 lm/m | 238 lm/ft

## EFFICACY

Luminaire: 82 lm/W

Light source: 131 lm/W

## LIFETIME

L90B10 60.000h

## HOUSING

Aluminum, polyurethane

## ELECTRICAL

Segment power: 9.6 W

Power per meter/feet: 9.6 W/m

Voltage: 24 VDC

## TEMPERATURE

Tc max <75°C ( 167°F )

Operating: -25°C...+50°C ( -13°F...122°F )

## OTHER DETAILS

IP67 protection

Dimmable

Install in well-ventilated areas only

## DIMENSIONS

Width: 16 mm (0.63")

Height: 6 mm (0.24")

Length: 1004 mm | 3.3'

Possible allowed deviation of optical and electrical values are  $\pm 15\%$ . Allowed measurement uncertainty  $\pm 7\%$ .  
All values in datasheet are for reference only and customers should take these values on their own risk. HOLECTRON reserves the right for changes without prior notice.