



OUTLINE IP67 TUNABLE WHITE

Outline A002M IEC AGY ECL / TW56/Nx G4 09W 820/850 L1000
Luminaire segment



COLORS

Grey housing

PHOTOMETRICS

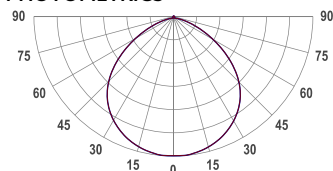

SEGMENT LAYOUT

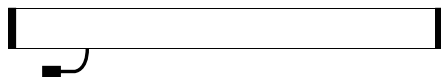

Luminaire type segment

CONNECTION TYPE

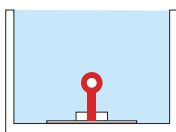

End exit wire

TECHNICAL DRAWING

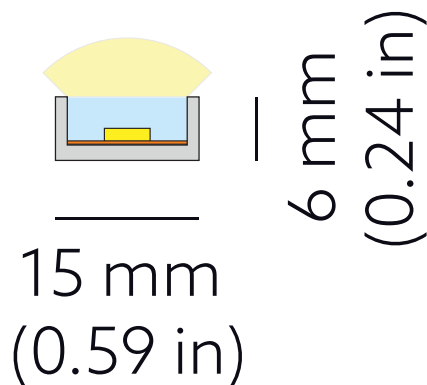

SPECTRUM

Warm LED: CRI 80+ 2000K

Cold LED: CRI 80+ 5000K

3-Step MacAdam

COVER

Clear

LUMINOUS FLUX

Per segment: 800 lm

Light source (per segment): 1282 lm

Per meter/feet: 800 lm/m | 244 lm/ft

EFFICACY

Luminaire: 83 lm/W

Light source: 134 lm/W

LIFETIME

L90B10 60.000h

HOUSING

Aluminum, polyurethane

ELECTRICAL

Segment power: 9.6 W

Power per meter/feet: 9.6 W/m

Voltage: 24 VDC

TEMPERATURE

Tc max <75°C (167°F)

Operating: -25°C...+50°C (-13°F...122°F)

OTHER DETAILS

IP67 protection

Dimmable

Install in well-ventilated areas only

DIMENSIONS

Width: 16 mm (0.63")

Height: 6 mm (0.24")

Length: 1004 mm | 3.3'

Possible allowed deviation of optical and electrical values are ±15%. Allowed measurement uncertainty ±7%.
All values in datasheet are for reference only and customers should take these values on their own risk. HOLECTRON reserves the right for changes without prior notice.