

NEMAN X - TRIMLESS CONTINUOUS

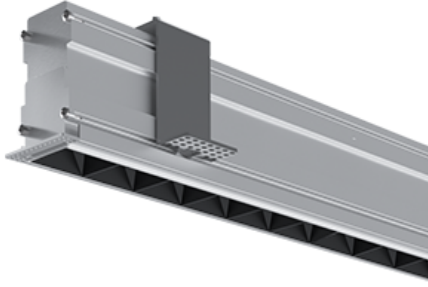

Neman-X T STA PW X3-05 D30 927 L1000 DALI

Start module for continuous line system

Product code: NMX T STA PW X3-05 B D30 927 1000 D

Article No.: F5TBDCPBBD1000D

Neman X Trimless luminaire contains changeable light engine. Luminaires lamps can be changed separately from the holding profile.

See luminaire drawings below for actual layout



COLORS



PHOTOMETRICS

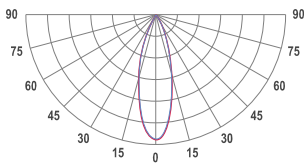

SEGMENT TYPE LAYOUT

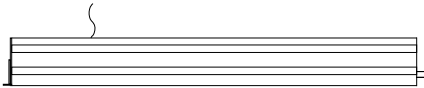

Start module

TECHNICAL DRAWING

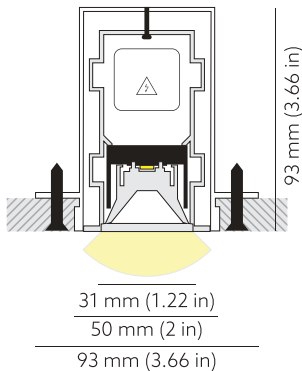

MOUNTING

Trimless type

SPECTRUM

2700K
CRI 90+
3-Step MacAdam

OPTICS

30°

LUMINOUS FLUX*

Luminaire: 1556 Lm
Light source: 1788 Lm

EFFICACY

Luminaire: 74 Lm/W
Light source: 85 Lm/W

LIFETIME

L90B10 60.000h

DIMMING

DALI, PushDim

HOUSING

Aluminum, plastic

ELECTRICAL

Luminaire power: 21 W
220-240 VAC 50/60 Hz
Integrated driver

OTHER DETAILS

IP40 ingress protection

DIMENSIONS

Width: 50mm / 2"
Height: 93mm / 3.66"
Length: 1001.5 mm / 3.3'
Distance between groups: 50 cm
Black-out length: 454.25 mm / 1.49'

MOUNTING HOLE

1010 x 53 mm / 3.31' x 0.17"

LEDS LAYOUT



* Luminous flux values are based on tests with white housing. Lower luminous flux values might apply for other housing colors.

Possible allowed deviation of optical and electrical values are $\pm 15\%$. Allowed measurement uncertainty $\pm 7\%$. All values in datasheet are for reference only and customers should take these values on their own risk. HOLECTRON reserves the right for changes without prior notice.