

# ULA L IP65

## Specification Sheet

HOLECTRON



**Area:** Outdoor Luminaires



**Category:** Linear lighting / decorative lighting / Cove



**Mounting:** Surface horizontal mounting / Surface vertical mounting / Wall mounting

Ula L IP65 is a modular linear LED light with a opal cover designed for long-term outdoor professional lighting applications.

These waterproof Ula L IP65 modular LED lights are fitted with the highest quality NICHIA LEDs, with a wide range of Color rendering index (CRI) and Color temperature (CCT) options to choose from. NICHIA LEDs guarantees highest quality lighting and super-high efficacy. This LED strip is available with 3 Step MacAdam or Single Bin LEDs. Opal cover ensures continuous light effect without dark spots.

Each module has integrated connectors for easy and reliable connection to other modules. Connectors are hidden inside the modules and segments connect into a seamless line.

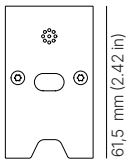

35 mm (1.39 in)

61.5 mm (2.42 in)



## TECHNICAL DATA

<b>Voltage</b>	24 V / 48 V
<b>LED lumen maintenance</b>	L90B10 > 60.000 h
<b>Light engine</b>	Any LED strip up to 33 W/m
<b>Cover</b>	Opal / Clear (available on request)
<b>Housing color</b>	● Black, ○ White, ● Grey, ● Custom
<b>Control</b>	Dimmable

PROJECT
DATE
QUANTITY
NOTES

**ORDER CODE**

NAME	SEGMENT TYPE	HOUSING COLOR	COVER	LUMINAIRE LENGTH	LED SOURCE	POWER	CRI 1	CCT 1
FXO.A1112							T9	
CRI 2	CCT 2 (only for TW strip)	STRIP LENGTH	CABLE TYPE	CONNECTOR	CABLE LENGTH	STANDART NAME	PACKING	
T9			HR			STD	PH	

SEGMENT TYPE	<b>I</b> individual luminaire, 2 end caps	<b>S</b> start segment, back wire exit, 1 end cap	<b>M</b> middle segment, back wire exit, no end caps	<b>E</b> end segment, back wire exit, 1 end cap	<b>F</b> full module, 2 end cap
--------------	---	--	---	--	---------------------------------------

WIRE EXIT	<b>B</b> back
-----------	------------------

HOUSING COLOR	<b>AGY</b> anodized gray	<b>PWE</b> white	<b>PBK</b> black	<b>PGY</b> gray	<b>CUSTOM</b> contact sales
---------------	-----------------------------	---------------------	---------------------	--------------------	--------------------------------

COVER	<b>ECL</b> clear	<b>EOP</b> opal homogenous
-------	---------------------	----------------------------------

LED SOURCE	FL112/NX	TW70/NN	RGB96/NX	RGBW48/NN
cutting increment	static white 62.5 mm (2.46")	tunable white 100mm (3.93")	RGB 62.5 mm (2.46")	RGBW 125 mm (4.92")
POWER	<b>4W</b> 4,8 W/m 1.5 W/ft 737 Lm/m (225 Lm/ft)* LOR  <b>9W</b> 9,8 W/m 2.9 W/ft 1460 Lm/m (445 lm/ft)* LOR  <b>14W</b> 14,4 W/m 4.4 W/ft 2170 Lm/m (662 lm/ft)* LOR  <b>19W</b> 19,2 W/m 5.8 W/ft 2868 Lm/m (874 lm/ft)* LOR  <b>24W</b> 24 W/m 7.3 W/ft 3552 Lm/m (1083 lm/ft)* LOR  <b>33W</b> 33,4 W/m 10.2 W/ft 4896Lm/m (1488 lm/ft)* LOR	<b>9W</b> 9,6 W/m 2.9 W/ft 1469 Lm/m (448 Lm/ft)* LOR  <b>19W</b> 19,2 W/m 5.8 W/ft 2900 Lm/m (884 Lm/ft)* LOR  <b>33W</b> 33,4 W/m 10.2 W/ft 4971Lm/m (1514 Lm/ft)* LOR	<b>11W</b> 11,52 W/m 3.5 W/ft 479 Lm/m (146 Lm/ft)* LOR  <b>14W</b> 9,6 W/m 2.9 W/ft 600 Lm/m (183Lm/ft)* LOR  <b>23W</b> 24 W/m 7.3 W/ft 962 Lm/m (293 Lm/ft)* LOR	<b>9W</b> 4,8 W/m 1.5 W/ft 608 Lm/m (185 Lm/ft)* LOR  <b>14W</b> 9,6 W/m 2.9 W/ft 886 Lm/m (270 Lm/ft)* LOR  <b>19W</b> 14,4 W/m 4.4 W/ft 1392 Lm/m (424 Lm/ft)* LOR  <b>24W</b> 24 W/m 7.3 W/ft 1924 Lm/m (587 Lm/ft)* LOR
CCT 1	<b>18 / 20 / 22 / 25 / 27 / 30 / 35 / 40 / 50 / 57 / 65</b> 1800K / 2000K / 2200K / 2500K / 2700K / 3000K / 3500K / 4000K / 5000K / 5700K / 6500K	<b>27-65</b> 2700K - 6500K		<b>18 / 20 / 22 / 25 / 27 / 30 / 35 / 40 / 50 / 57 / 65</b> 1800K / 2000K / 2200K / 2500K / 2700K / 3000K / 3500K / 4000K / 5000K / 5700K / 6500K

CONNECTOR	<b>NON</b> no connectors	<b>T1X</b> connector T1X
-----------	-----------------------------	-----------------------------

CABLE LENGTH	<b>L200</b> 200 mm 79" Default	<b>L500</b> 500 mm 1' 7.7"	<b>L1000</b> 1000 mm 3' 3.4"	<b>L2000</b> 2000 mm 5' 6.7"	<b>L3000</b> 3000 mm 9' 10.1"	<b>L5000</b> 5000 mm 16' 4.9"	<b>L9000</b> 9000 mm 29' 6.3"
--------------	---	----------------------------------	------------------------------------	------------------------------------	-------------------------------------	-------------------------------------	-------------------------------------

Lumen values is from bare LED strip. When assembled in profile, lumen value must be multiplied by LOR percentage to retrieve actual lumen value of assembled solution

\*The LOR was calculated using a white profile. The values may vary when using profiles of other colors.

CCT	1800K	2000K	2200K	2500K	2700K	3000K	3500K	4000K	5000K	5700K	6500K
MULTIPLIER NICHIA	0.54	0.58	0.63	0.68	0.95	1.00	1.02	1.04	1.04	1.01	1.01

**LED STRIP LENGTH**

For 62.5mm (2.46")

LED strip cutting increment

mm	L0063	L0125	L0188	L0250	L0313	L0375	L0438	L0500	L563	L0625	L0688	L0750	L0813	L0875	L0938	L1000	L1063	L1125	L1188	L1250	L1313	L1375	L1438	L1500
in	2.5"	4.9"	7.4"	9.8"	1' 0.3"	1' 2.8"	1' 5.2"	1' 7.7"	1' 10.2"	2' 0.6"	2' 3.1"	2' 5.5"	2' 8"	2' 10.4"	3' 0.9"	3' 3.4"	3' 5.9"	3' 8.3"	3' 10.8"	4' 1.2"	4' 3.7"	4' 6.1"	4' 8.6"	4' 11"

mm	L1563	L1625	L1688	L1750	L1813	L1875	L1938	L2000	L2063	L2125	L2188	L2250	L2313	L2375	L2438	L2500	L2563	L2625	L2688	L2750	L2813	L2875	L2938	L3000
in	5' 1.5"	5' 4"	5' 6.5"	5' 8.9"	5' 11.4"	6' 1.8"	6' 4.3"	6' 6.7"	6' 9.2"	6' 11.7"	7' 2.1"	7' 0.6"	7' 7.1"	7' 9.5"	7' 12"	8' 2.4"	8' 4.9"	8' 7.3"	8' 9.8"	9' 0.3"	9' 2.7"	9' 5.2"	9' 7.7"	9' 10.1"

For 100 mm (3.93")

LED strip cutting increment

mm	L0100	L0300	L0400	L0500	L0600	L0700	L0800	L0900	L1000	L1100	L1200	L1300	L1400	L1500	L1600	L1700	L1800	L1900	L2000	L2100	L2200	L2300	L2400	L2500
in	3.9"	11.8"	1' 3.7"	1' 7.7"	1' 11.6"	2' 3.6"	2' 7.5"	2' 11.4"	3' 3.4"	3' 7.3"	3' 11.2"	4' 3.2"	4' 7.1"	4' 11"	5' 3"	5' 6.9"	5' 10.9"	6' 2.8"	6' 6.7"	6' 10.7"	7' 2.6"	7' 6.4"	7' 10.5"	8' 2.4"

mm	L2600	L2700	L2800	L2900	L3000
in	8' 6.4"	8' 10.3"	9' 2.2"	9' 6.2"	9' 10.1"

For 125 mm (4.92")

LED strip cutting increment

mm	L0125	L0250	L0375	L0500	L0625	L0750	L0875	L1000	L1125	L1250	L1375	L1500	L1625	L1750	L1875	L2000	L2125	L2250	L2375	L2500	L2625	L2750	L2875	L3000
in	4.9"	9.8"	1' 2.8"	1' 7.7"	2' 0.6"	2' 5.5"	2' 10.4"	3' 3.4"	3' 8.3"	4' 1.2"	4' 6.1"	4' 11.1"	5' 4"	5' 8.9"	6' 1.8"	6' 6.7"	6' 11.7"	7' 4.6"	7' 9.5"	8' 2.4"	8' 7.3"	9' 0.3"	9' 5.2"	9' 10.1"

Module length = LED Strip Length + Offset

Offsets:

- Start module: 4mm (0.16 in)
- Middle module: 2mm (0.08 in)
- End module: 4mm (0.16 in)
- Individual module: 6mm (0.23 in)
- Full module: 6mm (0.23 in)

i.e. Start module length for L2000 LED strip is:

Start module length = 2000mm + 4mm

**Note:** Length tolerance ± 3mm/m (0.11 in)

**COVERS**

CODE	DESCRIPTION
------	-------------

ECL

Clear

EOP

Opal

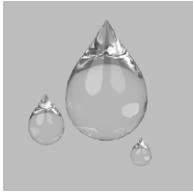

**ACCESSORIES**

CODE	DESCRIPTION
------	-------------

PRG.A1112.F02.RGY

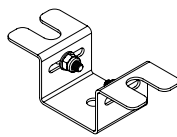

Screw-fixed mounting bracket

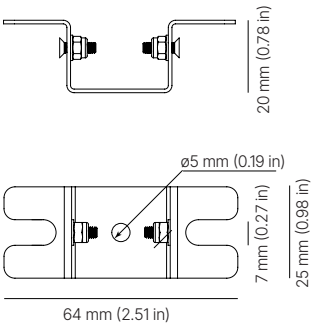

**DIMENSIONS**

**LUMINAIRE**

One cable, two endcaps

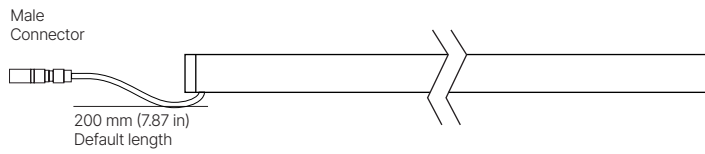

**START**

Two cables, endcap at the start

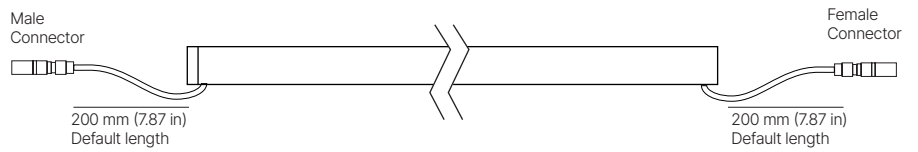

**MIDDLE**

Two cables, no endcaps

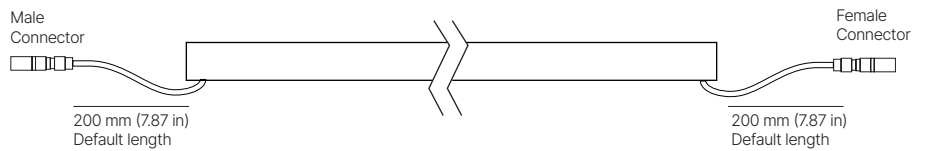

**END**

One cable, endcap at the end

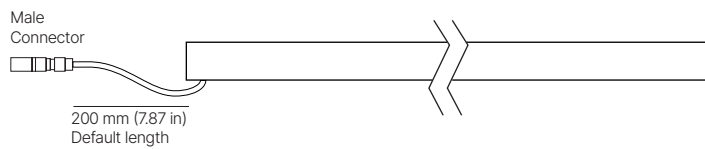

**FULL MODULE**

Two cables, two endcaps

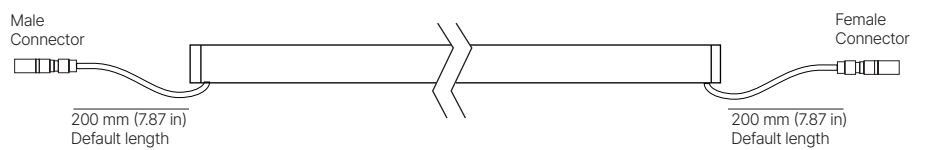

**WIRE EXIT**



**BACK**

Wire through a hole on the back of the profile

**CONNECTION TYPES**

**INDIVIDUAL module**

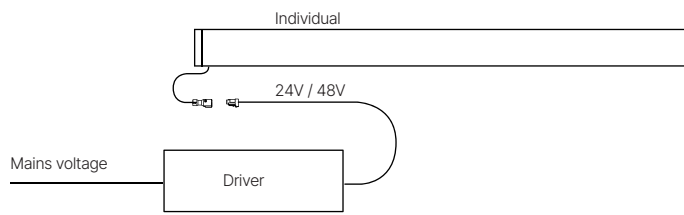

**FULL module**

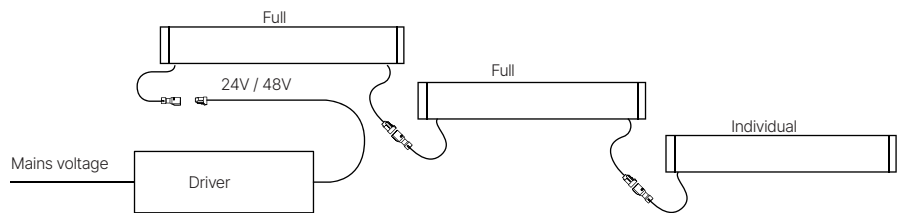

**CONTINUOUS LINE module (for OUTDOOR OPAL ONLY)**

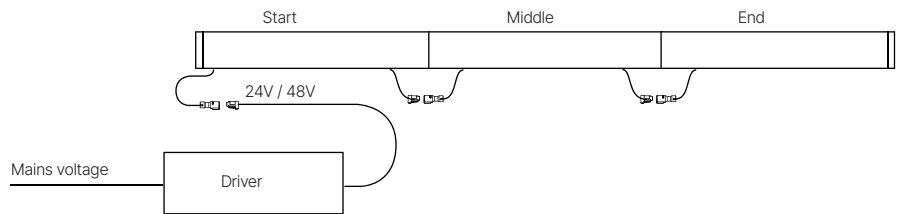

**CONNECTORS & WIRES**

**OUTDOOR**

**T1X - MALE CONNECTORS**

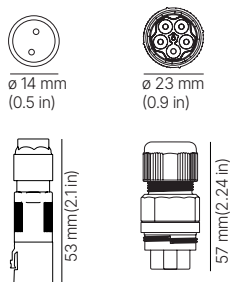

**T1X - FEMALE CONNECTORS**

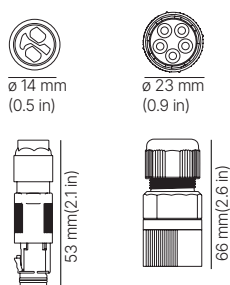

**WIRES**

**NT20N**

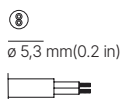

**NT60N**

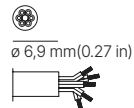

**WIRE LENGTHS**

CODE	L200	L500	L1000	L2000	L3000	L5000	L9000
LENGTH	200mm	500mm	1000mm	2000mm	3000mm	5000mm	9000mm
	7.9"	1' 7.7"	3' 3.4"	5' 6.7"	9' 10.1"	16' 4.9"	29' 6.3"

**TECHNICAL SPECIFICATIONS**

**CERTIFICATIONS**



UL approved



Made in Europe



L90B10  
60.000 hours



CE compliant



5- year warranty



NICHIA LEDs



IP67

**KEY BENEFITS**



3-step MacAdam LEDs



Stabilized current design



Wide 2000K-6500K white color range



CRI 90 +  
CRI 90+tri  
CRI 95  
Optisolis, RGB



Control sold separately;  
DALI, Casambi,  
1- 10V, Phase Cut



24V / 48V  
voltage input



Customization for your project



Ambient light



Available in any 0.5-3m length



Reverse voltage protection



External driver



Continuous line light effect without dark spots



UV, salt & solvent resistant

---

**OPTICS OUTDOOR**

**EOP**

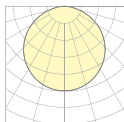

---

**APPLICATIONS**

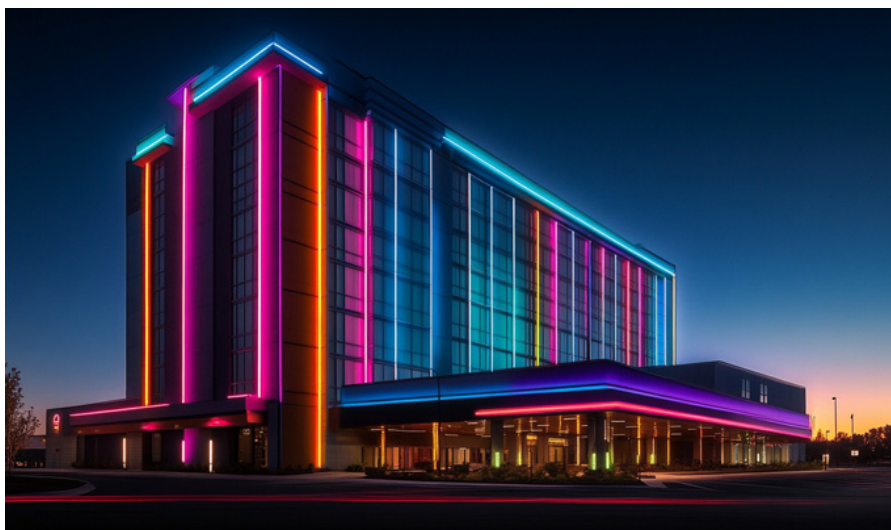

**MAX RUN**

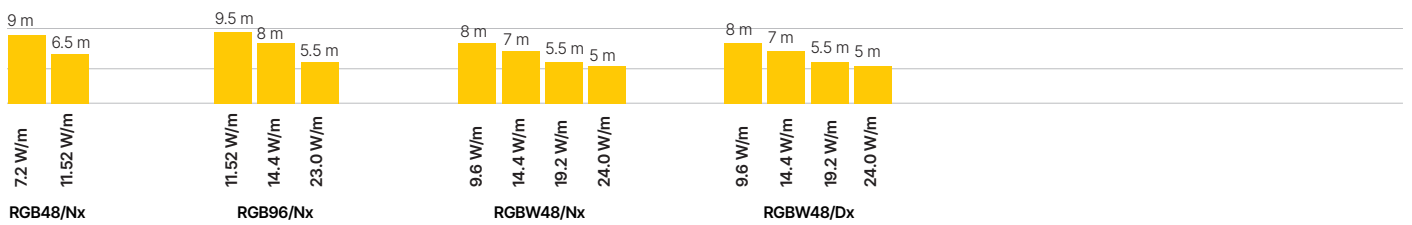
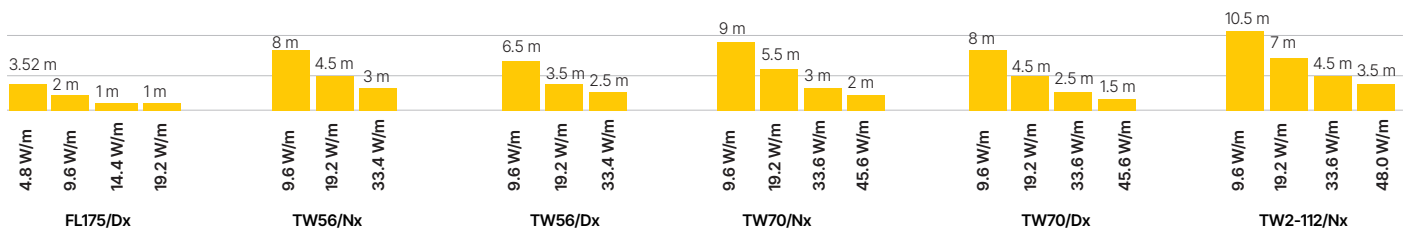
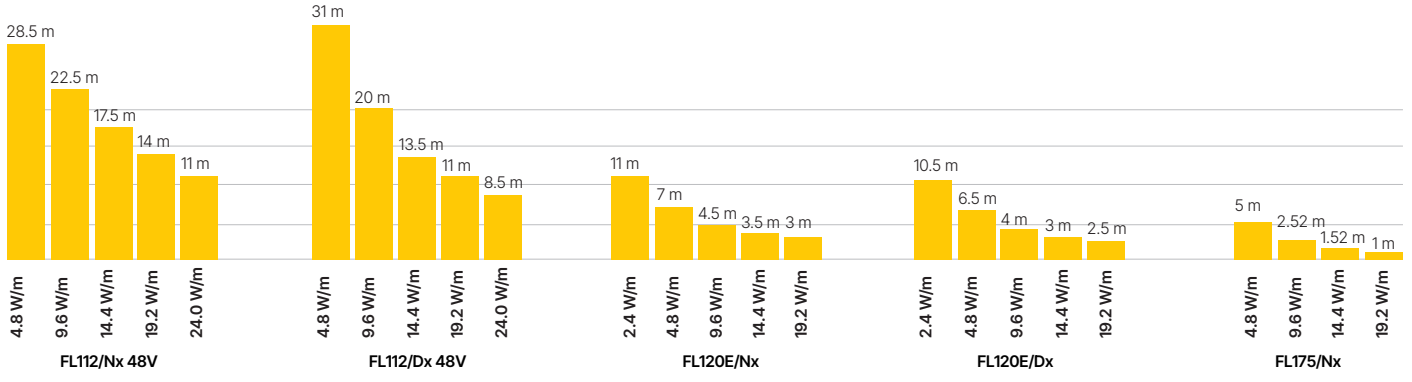
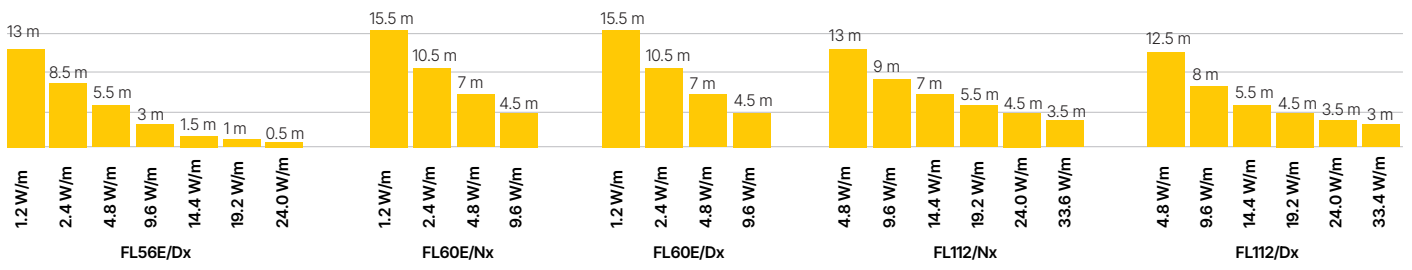
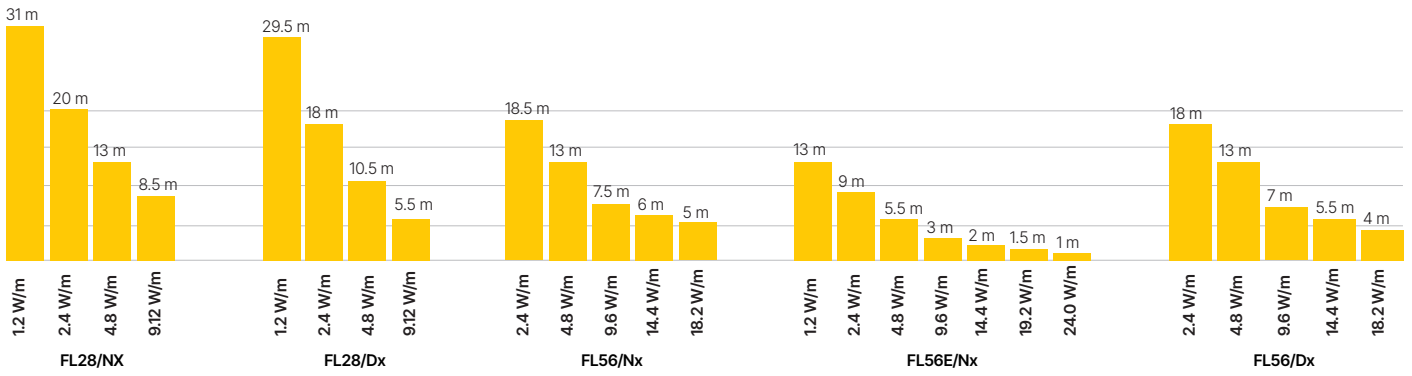

Possible max length connected to driver from single side.





**POWER SUPPLY - INDOOR**

CODE	DESCRIPTION
<p data-bbox="595 302 853 336"><b>DRI.V24.ILS.FO.SE.00001</b></p> 	<p data-bbox="1021 347 1236 380"><b>FIXED OUTPUT</b></p> <p data-bbox="1021 380 1484 504">100W 120 VAC(for NA) 220 - 240 VAC (for EU) 5 - year warranty Color: Static White Voltage: 24V DC Control: FO</p> <div data-bbox="1045 515 1220 593">   </div>

**POWER SUPPLY - OUTDOOR**

CODE	DESCRIPTION
<p data-bbox="595 880 869 913"><b>DRI.V24.OCO.FO.TR.00030</b></p> 	<p data-bbox="1021 936 1236 969"><b>FIXED OUTPUT</b></p> <p data-bbox="1021 969 1484 1097">96W 24V 90 - 305 VAC 5 - year warranty Color: Static White Voltage: 24V DC Control: FO</p> <div data-bbox="1045 1108 1220 1187">   </div>

<p data-bbox="595 1232 885 1265"><b>DRI.V24.OCO.DA.MW.00003</b></p> 	<p data-bbox="1021 1276 1109 1310"><b>DALI</b></p> <p data-bbox="1021 1310 1484 1444">120W 24V 100 - 240 VAC 5 - year warranty Color: Static White Voltage: 24V DC Control: DA</p> <div data-bbox="1045 1456 1220 1534">   </div>
---	---

<p data-bbox="595 1579 885 1612"><b>DRI.V24.OCO.FO.MW.00038</b></p> 	<p data-bbox="1021 1624 1125 1657"><b>0-10V</b></p> <p data-bbox="1021 1657 1484 1870">96W 24V 100 - 240 VAC MeanWell CV+CC driver 5 - year warranty Color: Static White Voltage: 24V DC PWM, Resistance Dimming: 0-10V 199×63×35.5mm</p> <div data-bbox="1045 1881 1220 1960">   </div>
---	--

**MAX PRODUCT LENGTH**

**WHITE 24V**

0.5mm2 (AWG 20)	4.8W/m (1.5W/ft)	9.6W/m (2.9W/ft)	14.4W/m (4.4W/ft)	19.2W/m (5.9W/ft)	24W/m (7.3W/ft)	33.6W/m (10.2W/ft)
Max cable length between luminaire and driver	Product max run					
1 m	12.5 m	8 m	6 m	4.5 m	4 m	3.5 m
2 m	12 m	7.5 m	5.5 m	4 m	3.5 m	3 m
3 m	11.5 m	7.5 m	5.5 m	4 m	3.5 m	2.5 m
5 m	11 m	7 m	5 m	3.5 m	3 m	2 m
10 m	8.5 m	5 m	4 m	2.5 m	2 m	1 m

**1.5mm2 (AWG 16)**

0.5mm2 (AWG 20)	4.8W/m (1.5W/ft)	9.6W/m (2.9W/ft)	14.4W/m (4.4W/ft)	19.2W/m (5.9W/ft)	24W/m (7.3W/ft)	33.6W/m (10.2W/ft)
Max cable length between luminaire and driver	Product max run					
1 m	12.5 m	8.5 m	6 m	4.5 m	4 m	3.5 m
2 m	12.5 m	8.5 m	6 m	4.5 m	4 m	3.5 m
3 m	12.5 m	8 m	6 m	4.5 m	4 m	3 m
5 m	12 m	8 m	5.5 m	4 m	3.5 m	3 m
10 m	11.5 m	7.5 m	5 m	3.5 m	3.5 m	2.5 m

**WHITE 48V**

0.5mm2 (AWG 20)	4.8W/m (1.5W/ft)	9.6W/m (2.9W/ft)	14.4W/m (4.4W/ft)	19.2W/m (5.9W/ft)	24W/m (7.3W/ft)
Max cable length between luminaire and driver	Product max run				
1 m	28 m	22 m	17 m	13 m	10.5 m
2 m	27.5 m	21.5 m	16.5 m	12.5 m	10 m
3 m	27 m	21 m	16 m	12 m	9.5 m
5 m	26.5 m	20.5 m	15 m	11 m	8.5 m
10 m	25 m	19 m	13.5 m	9 m	6.5 m

**1.5mm2 (AWG 16)**

0.5mm2 (AWG 20)	4.8W/m (1.5W/ft)	9.6W/m (2.9W/ft)	14.4W/m (4.4W/ft)	19.2W/m (5.9W/ft)	24W/m (7.3W/ft)
Max cable length between luminaire and driver	Product max run				
1 m	28.5 m	22 m	17 m	13.5 m	10.5 m
2 m	28 m	21.5 m	16.5 m	13 m	10 m
3 m	27.5 m	21.5 m	16.5 m	13 m	10 m
5 m	27.5 m	21 m	16 m	12.5 m	9.5 m
10 m	27 m	20.5 m	15.5 m	12 m	9 m

**24V TW 56 N5**

0.5mm2 (AWG 20)	9.6W/m (2.9W/ft)	19.2W/m (5.9W/ft)	33.6W/m (10.2W/ft)
Max cable length between luminaire and driver	Product max run		
1 m	7.5 m	4.5 m	2.5 m
2 m	7 m	4 m	2.5 m
3 m	7 m	4 m	2.5 m
5 m	6.5 m	4 m	2.5 m
10 m	5.5 m	3.5 m	2 m

**1.5mm2 (AWG 16)**

0.5mm2 (AWG 20)	9.6W/m (2.9W/ft)	19.2W/m (5.9W/ft)	33.6W/m (10.2W/ft)
Max cable length between luminaire and driver	Product max run		
1 m	7.5 m	4.5 m	2.5 m
2 m	7.5 m	4 m	2.5 m
3 m	7.5 m	4 m	2.5 m
5 m	7.5 m	4 m	2.5 m
10 m	7 m	4 m	2.5 m

**24V TW 70 N5**

0.5mm2 (AWG 20)	9.6W/m (2.9W/ft)	19.2W/m (5.9W/ft)	33.6W/m (10.2W/ft)	45.6W/m (14.6W/ft)
Max cable length between luminaire and driver	Product max run			
1 m	7.5 m	4.5 m	2.5 m	1.5 m
2 m	7.5 m	4 m	2.5 m	1.5 m
3 m	7.5 m	4 m	2.5 m	1.5 m
5 m	7 m	4 m	2 m	1.5 m
10 m	6.5 m	3.5 m	1.5 m	1 m

**1.5mm2 (AWG 16)**

0.5mm2 (AWG 20)	9.6W/m (2.9W/ft)	19.2W/m (5.9W/ft)	33.6W/m (10.2W/ft)	45.6W/m (14.6W/ft)
Max cable length between luminaire and driver	Product max run			
1 m	7.5 m	4.5 m	2.5 m	1.5 m
2 m	7.5 m	4 m	2.5 m	1.5 m
3 m	7.5 m	4 m	2.5 m	1.5 m
5 m	7.5 m	4 m	2.5 m	1.5 m
10 m	7.5 m	4 m	2 m	1.5 m

**MAX PRODUCT LENGTH**

**24V TW2 112**

0.5mm2 (AWG 20)	9.6W/m (2.9W/ft)	19.2W/m (5.9W/ft)	33.6W/m (10.2W/ft)	48W/m (14.6W/ft)
Max cable length between luminaire and driver	Product max run			
1 m	8 m	8 m	3 m	2.5 m
2 m	7.5 m	7.5 m	3 m	2.5 m
3 m	7.5 m	7.5 m	3 m	2 m
5 m	7 m	7 m	2.5 m	2 m
10 m	5.5 m	5.5 m	2 m	1.5 m

**1.5mm2 (AWG 16)**

Max cable length between luminaire and driver	Product max run			
1 m	8 m	5 m	3 m	2.5 m
2 m	8 m	5 m	3 m	2.5 m
3 m	8 m	5 m	3 m	2.5 m
5 m	8 m	5 m	3 m	2.5 m
10 m	7.5 m	4.5 m	2.5 m	2 m

**24V 48 RGB**

0.5mm2 (AWG 20)	7.2W/m (2.2W/ft)	11.5W/m (1.5W/ft)
Max cable length between luminaire and driver	Product max run	
1 m	8.5 m	5.5 m
2 m	8 m	5.5 m
3 m	8 m	5 m
5 m	7.5 m	4.5 m
10 m	7 m	3.5 m

**1.5mm2 (AWG 16)**

Max cable length between luminaire and driver	Product max run	
1 m	8.5 m	5.5 m
2 m	8.5 m	5.5 m
3 m	8.5 m	5.5 m
5 m	8.5 m	5.5 m
10 m	8 m	5 m

**24V 96 RGB**

0.5mm2 (AWG 20)	11.5W/m (1.5W/ft)	14.4W/m (4.4W/ft)	23W/m (4.4W/ft)
Max cable length between luminaire and driver	Product max run		
1 m	9 m	7.5 m	4.5 m
2 m	8.5 m	7 m	4 m
3 m	8.5 m	7 m	3.5 m
5 m	8 m	6 m	2.5 m
10 m	5.5 m	3.5 m	0

**1.5mm2 (AWG 16)**

Max cable length between luminaire and driver	Product max run		
1 m	9 m	7.5 m	4.5 m
2 m	9 m	7.5 m	4.5 m
3 m	9 m	7.5 m	4.5 m
5 m	8.5 m	7 m	4 m
10 m	8 m	6.5 m	3.5 m

## SAFETY / WARNINGS / DISCLOSURES

1. Install in accordance with national and local electrical code regulations.
2. Do not modify or disassemble this product beyond instructions or the warranty will be void.
3. Our channels, covers, end caps, and mounting brackets are also suitable for outdoor use with some considerations. Please consult with local Holecron representative to pick right fixtures for outdoor use.
4. Indoor (IP20) fixtures should never be mounted in areas receiving direct sunlight and locations where they can be submerged under water or might get in direct contact with water or puddling (rainfall, sprinkler, spray, etc.).
5. Avoid leaving gaps in any of the end cap or cover mating edges to the channel that will allow excess dust, debris, or water/moisture to enter the channel enclosure.
6. Actual product color may vary from what is pictured on this sheet and other print materials due to the limitations of photographic processes.
7. We reserve the right to modify and improve the design of our fixtures without prior notice. We cannot guarantee to match existing installed fixtures for subsequent orders or replacements in regards to product appearance, CCT, or lumen output.

## SAFETY / WARNINGS / DISCLOSURES

### Limited Warranty

This product has a five (5) year limited warranty from the date of shipment. This warranty does not include the additional accessories referenced in this specification sheet. Complete warranty details for fixtures and additional accessories are available online [download here](#). For warranty related questions please contact product support.

## CONSUMER'S ACKNOWLEDGMENT

Holecron stands behind its products when they are used properly and according to our specifications. By purchasing our products, the purchaser agrees and acknowledges that lighting design, configuration and installation is a complex process, wherein seemingly minor factors or changes in layout and infield adjustments can have a significant impact on an entire system. Choosing the correct components is essential. Holecron is able to work with the original purchaser to make an appropriate product selection to the extent of the limited information that the customer can provide, but it is virtually impossible for Holecron to design a system that foresees every unknown factor. For this reason, this Warranty does not cover problems caused by improper design, configuration or installation issues.

Any statement from a Holecron employee or agent regarding a customer's bill of goods and/or purchase order is NOT an acknowledgment that the products

purchased are designed and configured correctly. The purchase agrees and acknowledges that it is the customer's responsibility to adhere strictly to all information contained in the Product Specification Sheets. There is often more than one way to design, configure and layout an LED lighting application properly to achieve the same lighting effect. Holecron strongly recommends that licensed professionals be used in the design and installation of lighting systems that include Holecron products. The specifications include important information that a designer and installer should carefully review and strictly follow. Qualified designers and certified and/or licensed installers, with access to the final installation environment, customer goals, and Holecron product specifications can make the requisite decisions appropriate for a successful finished lighting application.

## HOLECTRON

HOLECTRON. All rights reserved.  
Specifications are subject to change without notice.  
Phone: +370 612 42446  
email: [info@holecron.com](mailto:info@holecron.com) | [www.holecron.com](http://www.holecron.com)