

Neman Blank IP65 Surface

HOLECTRON

Specification Sheet



Area: Outdoor Luminaires



Category: Linear lighting / decorative lighting / Cove



Mounting: Surface horizontal mounting / Surface vertical mounting / Wall mounting

Neman IP65 surface can be used as an individual luminaire for various outdoor lighting applications. Cover assures uniform, continuous light, and modern luminaire look.

Neman IP65 surface luminaire can be customized to any desired light output and almost any luminaire length to perfectly suit your project. The housing can be white, grey or black powder painted.

Various white, tunable white, RGB or RGB+W light sources can be used to achieve up to 5000 Lm/m light output and max. 33 W/m luminaire wattage.

Neman luminaire available with 3 Step MacAdam LEDs.

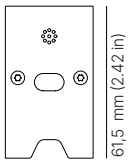

35 mm (1.39 in)

61.5 mm (2.42 in)

TECHNICAL DATA

Voltage	24 V / 48 V
LED lumen maintenance	L90B10 > 60.000 h
Light engine	Any LED strip up to 33 W/m
Cover	Opal / Clear / Honeycomb / Microprism
Housing color	● Black, ○ White, ● Grey, ● Custom
Control	Dimmable



PROJECT
DATE
QUANTITY
NOTES

ORDER CODE

NAME	SEGMENT TYPE	HOUSING COLOR	COVER	LUMINAIRE LENGTH	LED SOURCE	POWER	
FXO.A1112.NM.S.IP65							
CRI 1	CCT 1	CRI 2	CCT 2 (only for TW strip)	STRIP LENGTH	CABLE TYPE	CONNECTOR	CABLE LENGTH
T9		T9			HR		

SEGMENT TYPE	I individual luminaire, 2 end caps	F full module, 2 end cap
---------------------	---	---------------------------------------

WIRE EXIT	B back
------------------	------------------

HOUSING COLOR	PGY gray	PWE white	PBK black	CUSTOM contact sales
----------------------	--------------------	---------------------	---------------------	--------------------------------

COVER	ECL clear	60D.UGR.ECL honeycomb	EOP opal	PRM.ECL microprism
--------------	---------------------	---------------------------------	--------------------	------------------------------

LED SOURCE	FL112/NX static white 62.5 mm (2.46")	TW70/NN tunable white 100mm (3.93")	RGB96/NX RGB 62.5 mm (2.46")	RGBW48/NN RGBW 125 mm (4.92")
POWER	4W 4.8 W/m 1.5 W/ft 737 Lm/m (225 Lm/ft)* LOR 9W 9.6 W/m 2.9 W/ft 1460 Lm/m (445 Lm/ft)* LOR 14W 14.4 W/m 4.4 W/ft 2170 Lm/m (662 Lm/ft)* LOR 19W 19.2 W/m 5.8 W/ft 2868 Lm/m (874 Lm/ft)* LOR 24W 24 W/m 7.3 W/ft 3552 Lm/m (1083 Lm/ft)* LOR 33W 33.4 W/m 10.2 W/ft 4886Lm/m (1488 Lm/ft)* LOR	9W 9.6 W/m 2.9 W/ft 1469 Lm/m (448 Lm/ft)* LOR 19W 19.2 W/m 5.8 W/ft 2900 Lm/m (884 Lm/ft)* LOR 33W 33.4 W/m 10.2 W/ft 4971Lm/m (1514 Lm/ft)* LOR	11W 11.52 W/m 3.5 W/ft 479 Lm/m (146 Lm/ft)* LOR 14W 9.6 W/m 2.9 W/ft 600 Lm/m (183Lm/ft)* LOR 23W 24 W/m 7.3 W/ft 962 Lm/m (293 Lm/ft)* LOR	9W 4.8 W/m 1.5 W/ft 608 Lm/m (185 Lm/ft)* LOR 14W 9.6 W/m 2.9 W/ft 886 Lm/m (270 Lm/ft)* LOR 19W 14.4 W/m 4.4 W/ft 1392 Lm/m (424 Lm/ft)* LOR 24W 24 W/m 7.3 W/ft 1924 Lm/m (587 Lm/ft)* LOR
CCT 1	18 / 20 / 22 / 25 / 27 / 30 / 35 / 40 / 50 / 57 / 65 1800K / 2000K / 2200K / 2500K / 2700K / 3000K / 3500K / 4000K / 5000K / 5700K / 6500K	27-65 2700K - 6500K		18 / 20 / 22 / 25 / 27 / 30 / 35 / 40 / 50 / 57 / 65 1800K / 2000K / 2200K / 2500K / 2700K / 3000K / 3500K / 4000K / 5000K / 5700K / 6500K

CONNECTOR	NON no connectors	T1X connector T1X
------------------	-----------------------------	-----------------------------

CABLE LENGTH	L200 200 mm 7.9" Default	L500 500 mm 1' 7.7"	L1000 1000 mm 3' 3.4"	L2000 2000 mm 5' 6.7"	L3000 3000 mm 9' 10.1"	L5000 5000 mm 16' 4.9"	L9000 9000 mm 29' 6.3"
---------------------	--	----------------------------------	------------------------------------	------------------------------------	-------------------------------------	-------------------------------------	-------------------------------------

Lumen values is from bare LED strip. When assembled in profile, lumen value must be multiplied by LOR percentage to retrieve actual lumen value of assembled solution

*The LOR was calculated using a white profile. The values may vary when using profiles of other colors.

CCT	1800K	2000K	2200K	2500K	2700K	3000K	3500K	4000K	5000K	5700K	6500K
MULTIPLIER NICHA	0.54	0.58	0.63	0.68	0.95	1.00	1.02	1.04	1.04	1.01	1.01

LED STRIP LENGTH

For 62.5mm (2.46")

LED strip cutting increment

mm	L0063	L0125	L0188	L0250	L0313	L0375	L0438	L0500	L563	L0625	L0688	L0750	L0813	L0875	L0938	L1000	L1063	L1125	L1188	L1250	L1313	L1375	L1438	L1500
in	2.5"	4.9"	7.4"	9.8"	1' 0.3"	1' 2.8"	1' 5.2"	1' 7.7"	1' 10.2"	2' 0.6"	2' 3.1"	2' 5.5"	2' 8"	2' 10.4"	3' 0.9"	3' 3.4"	3' 5.9"	3' 8.3"	3' 10.8"	4' 1.2"	4' 3.7"	4' 6.1"	4' 8.6"	4' 11"
mm	L1563	L1625	L1688	L1750	L1813	L1875	L1938	L2000	L2063	L2125	L2188	L2250	L2313	L2375	L2438	L2500	L2563	L2625	L2688	L2750	L2813	L2875	L2938	L3000
in	5' 1.5"	5' 4"	5' 6.5"	5' 8.9"	5' 11.4"	6' 1.8"	6' 4.3"	6' 6.7"	6' 9.2"	6' 11.7"	7' 2.1"	7' 0.6"	7' 7.1"	7' 9.5"	7' 12"	8' 2.4"	8' 4.9"	8' 7.3"	8' 9.8"	9' 0.3"	9' 2.7"	9' 5.2"	9' 7.7"	9' 10.1"

For 100 mm (3.93")

LED strip cutting increment

mm	L0100	L0300	L0400	L0500	L0600	L0700	L0800	L0900	L1000	L1100	L1200	L1300	L1400	L1500	L1600	L1700	L1800	L1900	L2000	L2100	L2200	L2300	L2400	L2500
in	3.9"	11.8"	1' 3.7"	1' 7.7"	1' 11.6"	2' 3.6"	2' 7.5"	2' 11.4"	3' 3.4"	3' 7.3"	3' 11.2"	4' 3.2"	4' 7.1"	4' 11"	5' 3"	5' 6.9"	5' 10.9"	6' 2.8"	6' 6.7"	6' 10.7"	7' 2.6"	8' 6.4"	7' 10.5"	8' 2.4"
mm	L2600	L2700	L2800	L2900	L3000																			
in	8' 6.4"	8' 10.3"	9' 2.2"	9' 6.2"	9' 10.1"																			

For 125 mm (4.92")

LED strip cutting increment

mm	L0125	L0250	L0375	L0500	L0625	L0750	L0875	L1000	L1125	L1250	L1375	L1500	L1625	L1750	L1875	L2000	L2125	L2250	L2375	L2500	L2625	L2750	L2875	L3000
in	4.9"	9.8"	1' 2.8"	1' 7.7"	2' 0.6"	2' 5.5"	2' 10.4"	3' 3.4"	3' 8.3"	4' 1.2"	4' 6.1"	4' 11.1"	5' 4"	5' 8.9"	6' 1.8"	6' 6.7"	6' 11.7"	7' 4.6"	7' 9.5"	8' 2.4"	8' 7.3"	9' 0.3"	9' 5.2"	9' 10.1"

Module length = LED Strip Length + Offset

Offsets:

- Individual module: 6mm (0.23 in)
- Full module: 6mm (0.23 in)

i.e. Individual module length for L2000 LED strip is:

Individual module length = 2000mm + 6mm

Note: Length tolerance ± 3mm/m (0.11 in)

COVERS

CODE	DESCRIPTION
ECL	Clear
EOP	Opal
60D.UGR.ECL	Honeycomb
PRM.ECL	Microprism



ACCESSORIES

CODE	DESCRIPTION
PRG.A1112.F02.RGY	Screw-fixed mounting bracket
PRG.A1112.F07.RGY	Surface Hidden Holder

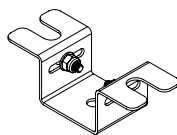
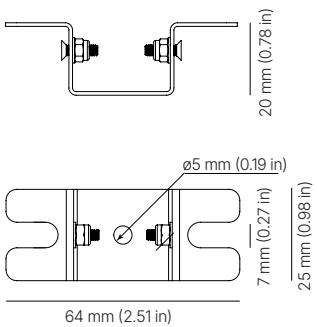

DIMENSIONS

LUMINAIRE

One cable, two endcaps

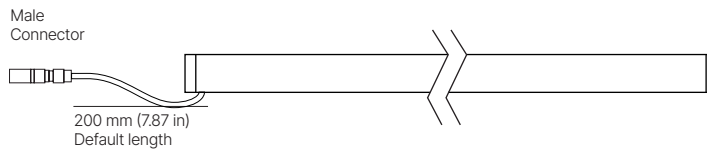

FULL MODULE

Two cables, two endcaps

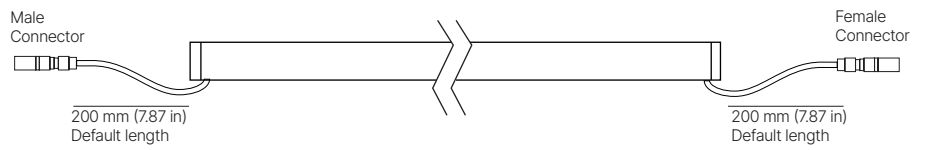

WIRE EXIT



BACK

Wire through a hole on the back of the profile

CONNECTION TYPES

INDIVIDUAL module

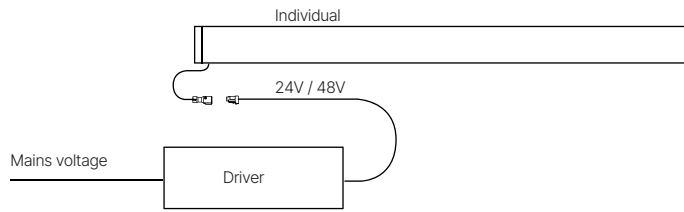

FULL module

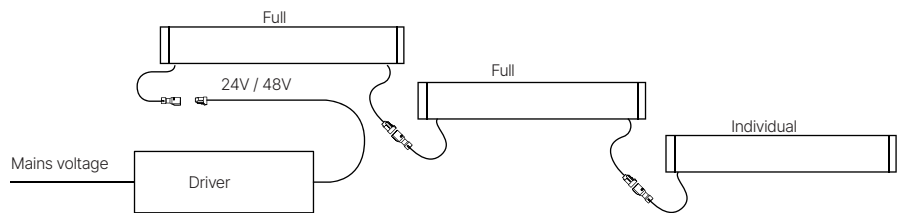

CONTINUOUS LINE module (for OUTDOOR OPAL ONLY)

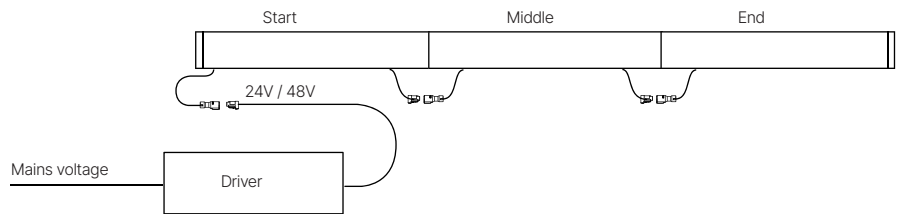

CONNECTORS & WIRES

OUTDOOR

T1X - MALE CONNECTORS

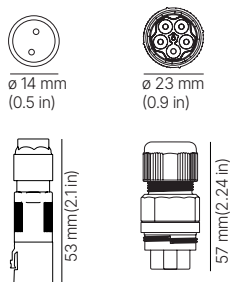

T1X - FEMALE CONNECTORS

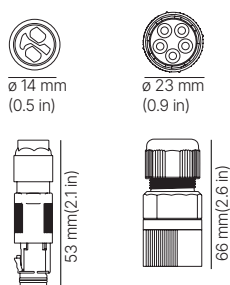

WIRES

NT20N

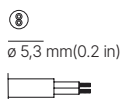

NT60N

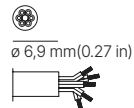

WIRE LENGTHS

CODE	L200	L500	L1000	L2000	L3000	L5000	L9000
LENGTH	200mm	500mm	1000mm	2000mm	3000mm	5000mm	9000mm
	7.9"	1' 7.7"	3' 3.4"	5' 6.7"	9' 10.1"	16' 4.9"	29' 6.3"

TECHNICAL SPECIFICATIONS

SERTIFICATIONS



UL approved



Made in Europe



L90B10
60.000 hours



CE compliant



5- year warranty



NICHIA LEDs



KEY BENEFITS



IP65



UV, salt & solvent resistant



Thermal resistance:
-25° – +50°



3-step MacAdam LEDs



Stabilized current design



Wide 2000K-6500K white color range



CRI 90 + CRI 90+tri Optisolis, RGB



Control sold separately; DALI, Casambi, 1- 10V, Phase Cut



24V / 48V voltage input



Customization for your project



External driver



Continuous line light effect without dark spots



Reverse voltage protection

LIGHT OPTIONS

CLR

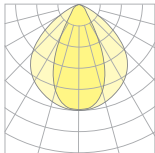

PRM

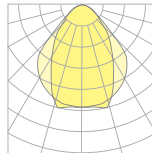

OPL

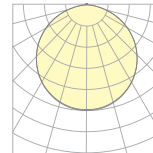

HB

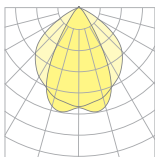

APPLICATIONS

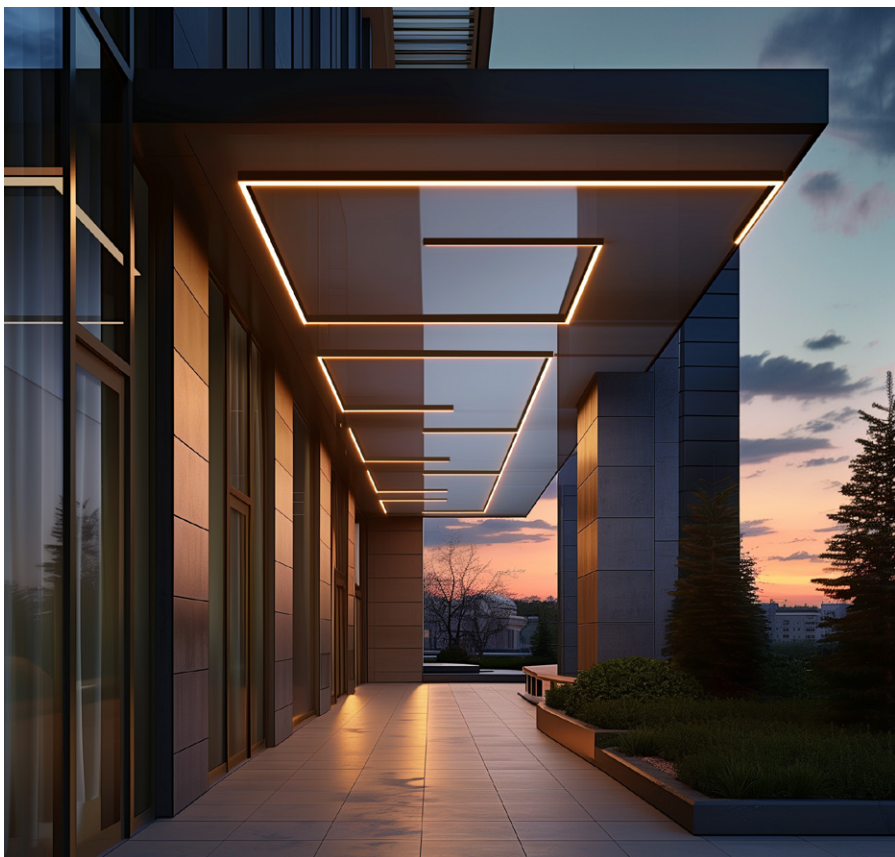

MAX RUN

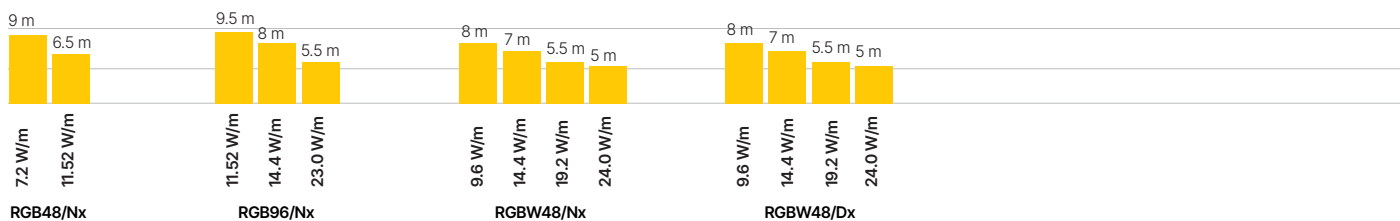
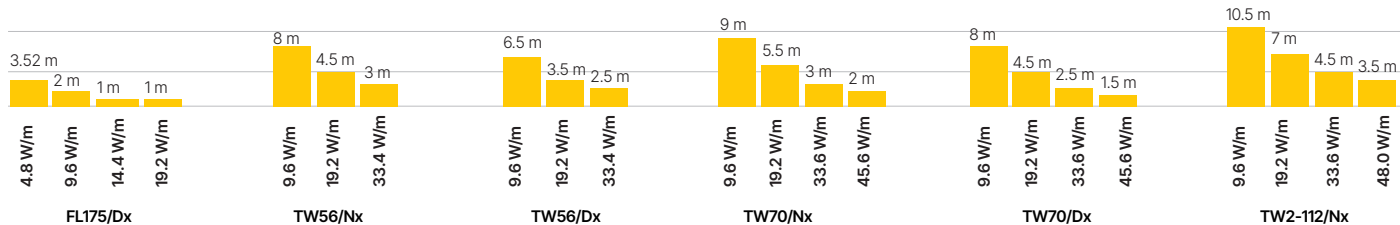
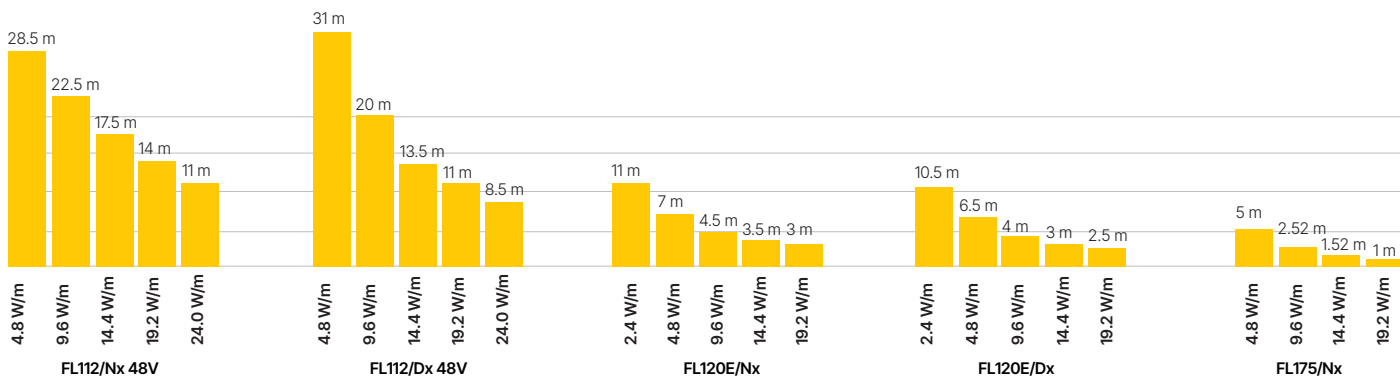
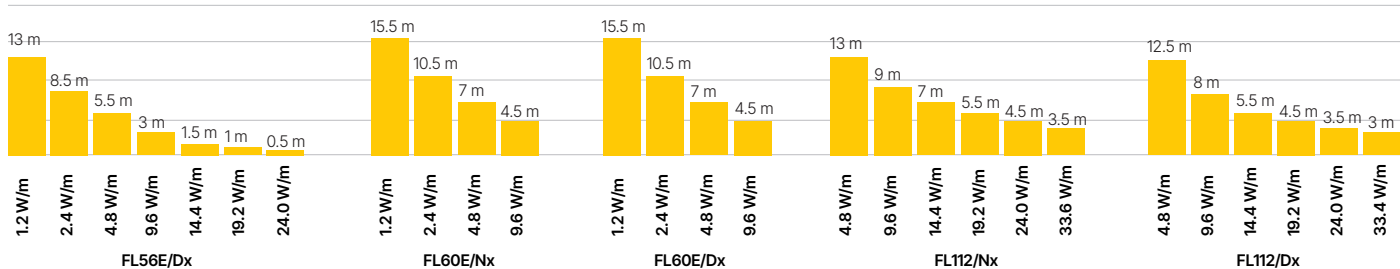
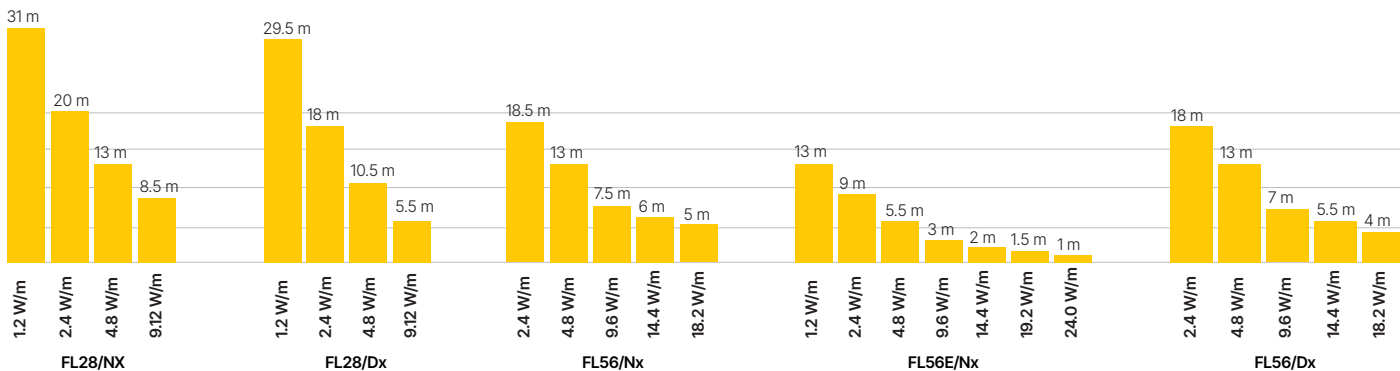

Possible max length connected to driver from single side.





POWER SUPPLY - INDOOR

CODE	DESCRIPTION
<p data-bbox="595 302 853 336">DRI.V24.ILS.FO.SE.00001</p> 	<p data-bbox="1021 347 1236 380">FIXED OUTPUT</p> <p data-bbox="1021 380 1484 504">100W 120 VAC(for NA) 220 - 240 VAC (for EU) 5 - year warranty Color: Static White Voltage: 24V DC Control: FO</p> <div data-bbox="1045 515 1220 593">   </div>

POWER SUPPLY - OUTDOOR

CODE	DESCRIPTION
<p data-bbox="595 878 869 911">DRI.V24.OCO.FO.TR.00030</p> 	<p data-bbox="1021 934 1236 967">FIXED OUTPUT</p> <p data-bbox="1021 967 1484 1097">96W 24V 90 - 305 VAC 5 - year warranty Color: Static White Voltage: 24V DC Control: FO</p> <div data-bbox="1045 1108 1220 1187">   </div>

<p data-bbox="595 1232 885 1265">DRI.V24.OCO.DA.MW.00003</p> 	<p data-bbox="1021 1276 1109 1310">DALI</p> <p data-bbox="1021 1310 1484 1444">120W 24V 100 - 240 VAC 5 - year warranty Color: Static White Voltage: 24V DC Control: DA</p> <div data-bbox="1045 1456 1220 1534">   </div>
---	---

<p data-bbox="595 1579 885 1612">DRI.V24.OCO.FO.MW.00038</p> 	<p data-bbox="1021 1624 1125 1657">0-10V</p> <p data-bbox="1021 1657 1484 1870">96W 24V 100 - 240 VAC MeanWell CV+CC driver 5 - year warranty Color: Static White Voltage: 24V DC PWM, Resistance Dimming: 0-10V 199×63×35.5mm</p> <div data-bbox="1045 1881 1220 1960">   </div>
---	--

MAX PRODUCT LENGTH

WHITE 24V

0.5mm2 (AWG 20)	4.8W/m (1.5W/ft)	9.6W/m (2.9W/ft)	14.4W/m (4.4W/ft)	19.2W/m (5.9W/ft)	24W/m (7.3W/ft)	33.6W/m (10.2W/ft)
Max cable length between luminaire and driver	Product max run					
1 m	12.5 m	8 m	6 m	4.5 m	4 m	3.5 m
2 m	12 m	7.5 m	5.5 m	4 m	3.5 m	3 m
3 m	11.5 m	7.5 m	5.5 m	4 m	3.5 m	2.5 m
5 m	11 m	7 m	5 m	3.5 m	3 m	2 m
10 m	8.5 m	5 m	4 m	2.5 m	2 m	1 m

1.5mm2 (AWG 16)

0.5mm2 (AWG 20)	4.8W/m (1.5W/ft)	9.6W/m (2.9W/ft)	14.4W/m (4.4W/ft)	19.2W/m (5.9W/ft)	24W/m (7.3W/ft)	33.6W/m (10.2W/ft)
Max cable length between luminaire and driver	Product max run					
1 m	12.5 m	8.5 m	6 m	4.5 m	4 m	3.5 m
2 m	12.5 m	8.5 m	6 m	4.5 m	4 m	3.5 m
3 m	12.5 m	8 m	6 m	4.5 m	4 m	3 m
5 m	12 m	8 m	5.5 m	4 m	3.5 m	3 m
10 m	11.5 m	7.5 m	5 m	3.5 m	3.5 m	2.5 m

WHITE 48V

0.5mm2 (AWG 20)	4.8W/m (1.5W/ft)	9.6W/m (2.9W/ft)	14.4W/m (4.4W/ft)	19.2W/m (5.9W/ft)	24W/m (7.3W/ft)
Max cable length between luminaire and driver	Product max run				
1 m	28 m	22 m	17 m	13 m	10.5 m
2 m	27.5 m	21.5 m	16.5 m	12.5 m	10 m
3 m	27 m	21 m	16 m	12 m	9.5 m
5 m	26.5 m	20.5 m	15 m	11 m	8.5 m
10 m	25 m	19 m	13.5 m	9 m	6.5 m

1.5mm2 (AWG 16)

0.5mm2 (AWG 20)	4.8W/m (1.5W/ft)	9.6W/m (2.9W/ft)	14.4W/m (4.4W/ft)	19.2W/m (5.9W/ft)	24W/m (7.3W/ft)
Max cable length between luminaire and driver	Product max run				
1 m	28.5 m	22 m	17 m	13.5 m	10.5 m
2 m	28 m	21.5 m	16.5 m	13 m	10 m
3 m	27.5 m	21.5 m	16.5 m	13 m	10 m
5 m	27.5 m	21 m	16 m	12.5 m	9.5 m
10 m	27 m	20.5 m	15.5 m	12 m	9 m

24V TW 56 N5

0.5mm2 (AWG 20)	9.6W/m (2.9W/ft)	19.2W/m (5.9W/ft)	33.6W/m (10.2W/ft)
Max cable length between luminaire and driver	Product max run		
1 m	7.5 m	4.5 m	2.5 m
2 m	7 m	4 m	2.5 m
3 m	7 m	4 m	2.5 m
5 m	6.5 m	4 m	2.5 m
10 m	5.5 m	3.5 m	2 m

1.5mm2 (AWG 16)

0.5mm2 (AWG 20)	9.6W/m (2.9W/ft)	19.2W/m (5.9W/ft)	33.6W/m (10.2W/ft)
Max cable length between luminaire and driver	Product max run		
1 m	7.5 m	4.5 m	2.5 m
2 m	7.5 m	4 m	2.5 m
3 m	7.5 m	4 m	2.5 m
5 m	7.5 m	4 m	2.5 m
10 m	7 m	4 m	2.5 m

24V TW 70 N5

0.5mm2 (AWG 20)	9.6W/m (2.9W/ft)	19.2W/m (5.9W/ft)	33.6W/m (10.2W/ft)	45.6W/m (14.6W/ft)
Max cable length between luminaire and driver	Product max run			
1 m	7.5 m	4.5 m	2.5 m	1.5 m
2 m	7.5 m	4 m	2.5 m	1.5 m
3 m	7.5 m	4 m	2.5 m	1.5 m
5 m	7 m	4 m	2 m	1.5 m
10 m	6.5 m	3.5 m	1.5 m	1 m

1.5mm2 (AWG 16)

0.5mm2 (AWG 20)	9.6W/m (2.9W/ft)	19.2W/m (5.9W/ft)	33.6W/m (10.2W/ft)	45.6W/m (14.6W/ft)
Max cable length between luminaire and driver	Product max run			
1 m	7.5 m	4.5 m	2.5 m	1.5 m
2 m	7.5 m	4 m	2.5 m	1.5 m
3 m	7.5 m	4 m	2.5 m	1.5 m
5 m	7.5 m	4 m	2.5 m	1.5 m
10 m	7.5 m	4 m	2 m	1.5 m

MAX PRODUCT LENGTH

24V TW2 112

0.5mm2 (AWG 20)	9.6W/m (2.9W/ft)	19.2W/m (5.9W/ft)	33.6W/m (10.2W/ft)	48W/m (14.6W/ft)
Max cable length between luminaire and driver	Product max run			
1 m	8 m	8 m	3 m	2.5 m
2 m	7.5 m	7.5 m	3 m	2.5 m
3 m	7.5 m	7.5 m	3 m	2 m
5 m	7 m	7 m	2.5 m	2 m
10 m	5.5 m	5.5 m	2 m	1.5 m

1.5mm2 (AWG 16)

Max cable length between luminaire and driver	Product max run			
1 m	8 m	5 m	3 m	2.5 m
2 m	8 m	5 m	3 m	2.5 m
3 m	8 m	5 m	3 m	2.5 m
5 m	8 m	5 m	3 m	2.5 m
10 m	7.5 m	4.5 m	2.5 m	2 m

24V 48 RGB

0.5mm2 (AWG 20)	7.2W/m (2.2W/ft)	11.5W/m (1.5W/ft)
Max cable length between luminaire and driver	Product max run	
1 m	8.5 m	5.5 m
2 m	8 m	5.5 m
3 m	8 m	5 m
5 m	7.5 m	4.5 m
10 m	7 m	3.5 m

1.5mm2 (AWG 16)

Max cable length between luminaire and driver	Product max run	
1 m	8.5 m	5.5 m
2 m	8.5 m	5.5 m
3 m	8.5 m	5.5 m
5 m	8.5 m	5.5 m
10 m	8 m	5 m

24V 96 RGB

0.5mm2 (AWG 20)	11.5W/m (1.5W/ft)	14.4W/m (4.4W/ft)	23W/m (4.4W/ft)
Max cable length between luminaire and driver	Product max run		
1 m	9 m	7.5 m	4.5 m
2 m	8.5 m	7 m	4 m
3 m	8.5 m	7 m	3.5 m
5 m	8 m	6 m	2.5 m
10 m	5.5 m	3.5 m	0

1.5mm2 (AWG 16)

Max cable length between luminaire and driver	Product max run		
1 m	9 m	7.5 m	4.5 m
2 m	9 m	7.5 m	4.5 m
3 m	9 m	7.5 m	4.5 m
5 m	8.5 m	7 m	4 m
10 m	8 m	6.5 m	3.5 m

SAFETY / WARNINGS / DISCLOSURES

1. Install in accordance with national and local electrical code regulations.
2. Do not modify or disassemble this product beyond instructions or the warranty will be void.
3. Our channels, covers, end caps, and mounting brackets are also suitable for outdoor use with some considerations. Please consult with local Holecron representative to pick right fixtures for outdoor use.
4. Indoor (IP20) fixtures should never be mounted in areas receiving direct sunlight and locations where they can be submerged under water or might get in direct contact with water or puddling (rainfall, sprinkler, spray, etc.).
5. Avoid leaving gaps in any of the end cap or cover mating edges to the channel that will allow excess dust, debris, or water/moisture to enter the channel enclosure.
6. Actual product color may vary from what is pictured on this sheet and other print materials due to the limitations of photographic processes.
7. We reserve the right to modify and improve the design of our fixtures without prior notice. We cannot guarantee to match existing installed fixtures for subsequent orders or replacements in regards to product appearance, CCT, or lumen output.

SAFETY / WARNINGS / DISCLOSURES

Limited Warranty

This product has a five (5) year limited warranty from the date of shipment. This warranty does not include the additional accessories referenced in this specification sheet. Complete warranty details for fixtures and additional accessories are available online [download here](#). For warranty related questions please contact product support.

CONSUMER'S ACKNOWLEDGMENT

Holecron stands behind its products when they are used properly and according to our specifications. By purchasing our products, the purchaser agrees and acknowledges that lighting design, configuration and installation is a complex process, wherein seemingly minor factors or changes in layout and infield adjustments can have a significant impact on an entire system. Choosing the correct components is essential. Holecron is able to work with the original purchaser to make an appropriate product selection to the extent of the limited information that the customer can provide, but it is virtually impossible for Holecron to design a system that foresees every unknown factor. For this reason, this Warranty does not cover problems caused by improper design, configuration or installation issues.

Any statement from a Holecron employee or agent regarding a customer's bill of goods and/or purchase order is NOT an acknowledgment that the products

purchased are designed and configured correctly. The purchase agrees and acknowledges that it is the customer's responsibility to adhere strictly to all information contained in the Product Specification Sheets. There is often more than one way to design, configure and layout an LED lighting application properly to achieve the same lighting effect. Holecron strongly recommends that licensed professionals be used in the design and installation of lighting systems that include Holecron products. The specifications include important information that a designer and installer should carefully review and strictly follow. Qualified designers and certified and/or licensed installers, with access to the final installation environment, customer goals, and Holecron product specifications can make the requisite decisions appropriate for a successful finished lighting application.

HOLECTRON

HOLECTRON. All rights reserved.
Specifications are subject to change without notice.
Phone: +370 612 42446
email: info@holecron.com | www.holecron.com