

Area: Indoor Luminaires



Category: Linear lighting / decorative lighting / wall lighting



Mounting: Recessed horizontal mounting / recessed vertical mounting / Wall mounting

A003x recess mount fixture for dotless direct lighting applications. Can be installed in any drywall thickness to create a clean and seamless aesthetics.

Take advantage of widest CCT range or customize A003x with Tunable white, RGB, RGBW LED strips to create stunning recessed lighting.

Fixtures can be linked up to 14m (46') depending on the output.

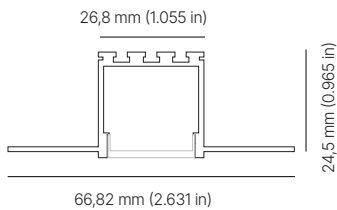

TECHNICAL DATA

Voltage	24 V / 48 V
LED lumen maintenance	L90B10 > 60.000 h
Light engine	Any LED strip up to 24 W/m
Control	Dimmable



PROJECT
DATE
QUANTITY
NOTES

ORDER CODE

NAME	SEGMENT TYPE	HOUSING COLOR	COVER	LUMINAIRE LENGTH	LED SOURCE	POWER	CRI 1	CCT 1
FXL.A003x							T9	
CRI 2	CCT 2 (only for TW strip)	STRIP LENGTH	CABLE TYPE	CONNECTOR	CABLE LENGTH	STANDART NAME	PACKING	
T9			HR			STD	PH	

SEGMENT TYPE	I individual luminaire, 2 end caps	S start segment, back / side wire exit, 1 end cap	M middle segment, back / side wire exit, no end caps	E end segment, back / side wire exit, 1 end cap	F full module, 2 end cap
--------------	---	---	--	---	---------------------------------------

WIRE EXIT	B back	S side	E end
-----------	------------------	------------------	-----------------

HOUSING COLOR	AGY anodized gray	PWE white	PBK black	PGY gray	CUSTOM contact sales
---------------	-----------------------------	---------------------	---------------------	--------------------	--------------------------------

COVER	16X.3.CLR clear	16X.3.OPL opal homogenous
-------	---------------------------	--

LED SOURCE	FL112/NX static white 62.5 mm (2.46")	TW70/NN tunable white 100mm (3.93")	RGB96/NX RGB 62.5 mm (2.46")	RGBW48/NN RGBW 125 mm (4.92")
------------	--	--	---	--

POWER	4W 4,8 W/m 1.5 W/ft 737 Lm/m (225 Lm/ft) * LOR 9W 9,6 W/m 2.9 W/ft 1460 Lm/m (445 Lm/ft) * LOR 14W 14,4 W/m 4.4 W/ft 2170 Lm/m (662 Lm/ft) * LOR 19W 19,2 W/m 5.8 W/ft 2868 Lm/m (874 Lm/ft) * LOR 24W 24 W/m 7.3 W/ft 3552 Lm/m (1083 Lm/ft) *LOR	9W 9,6 W/m 2.9 W/ft 1469 Lm/m (448 Lm/ft) * LOR 19W 19,2 W/m 5.8 W/ft 2900 Lm/m (884 Lm/ft) * LOR	11W 11,52 W/m 3.5 W/ft 479 Lm/m (146 Lm/ft) * LOR 14W 9,6 W/m 2.9 W/ft 600 Lm/m (183Lm/ft) * LOR 23W 24 W/m 7.3 W/ft 962 Lm/m (293 Lm/ft) * LOR	9W 4,8 W/m 1.5 W/ft 608 Lm/m (185 Lm/ft) * LOR 14W 9,6 W/m 2.9 W/ft 886 Lm/m (270 Lm/ft) * LOR 19W 14,4 W/m 4.4 W/ft 1392 Lm/m (424 Lm/ft) * LOR 24W 24 W/m 7.3 W/ft 1924 Lm/m (587 Lm/ft) * LOR
-------	---	--	--	---

CCT 1	18 / 20 / 22 / 25 / 27 / 30 / 35 / 40 / 50 / 57 / 65 1800K / 2000K / 2200K / 2500K / 2700K / 3000K / 3500K / 4000K / 5000K / 5700K / 6500K	27-65 2700K - 6500K	18 / 20 / 22 / 25 / 27 / 30 / 35 / 40 / 50 / 57 / 65 1800K / 2000K / 2200K / 2500K / 2700K / 3000K / 3500K / 4000K / 5000K / 5700K / 6500K
-------	--	-------------------------------	--

CONNECTOR	NON no connectors	P1X connector P1X
-----------	-----------------------------	-----------------------------

CABLE LENGTH	L200 200 mm 79" Default	L500 500 mm 1' 7.7"	L1000 1000 mm 3' 3.4"	L2000 2000 mm 5' 6.7"	L3000 3000 mm 9' 10.1"	L5000 5000 mm 16' 4.9"	L9000 9000 mm 29' 6.3"
--------------	---	----------------------------------	------------------------------------	------------------------------------	-------------------------------------	-------------------------------------	-------------------------------------

*The LOR was calculated using a white profile. The values may vary when using profiles of other colors.

Lumen values is from bare LED strip. When assembled in profile, lumen value must be multiplied by LOR percentage to retrieve actual lumen value of assembled solution

CCT	1800K	2000K	2200K	2500K	2700K	3000K	3500K	4000K	5000K	5700K	6500K
MULTIPLIER NICHIA	0.54	0.58	0.63	0.68	0.95	1.00	1.02	1.04	1.04	1.01	1.01

LED STRIP LENGTH

For 62.5mm (2.46")

LED strip cutting increment		L0063	L0125	L0188	L0250	L0313	L0375	L0438	L0500	L563	L0625	L0688	L0750	L0813	L0875	L0938	L1000	L1063	L1125	L1188	L1250	L1313	L1375	L1438	L1500
mm		63	125	188	250	313	375	438	500	563	625	688	750	813	875	938	1000	1063	1125	1188	1250	1313	1375	1438	1500
in		2.5"	4.9"	7.4"	9.8"	1' 0.3"	1' 2.8"	1' 5.2"	1' 7.7"	1' 10.2"	2' 0.6"	2' 3.1"	2' 5.5"	2' 8"	2' 10.4"	3' 0.9"	3' 3.4"	3' 5.9"	3' 8.3"	3' 10.8"	4' 1.2"	4' 3.7"	4' 6.1"	4' 8.6"	4' 11"

mm		L1563	L1625	L1688	L1750	L1813	L1875	L1938	L2000	L2063	L2125	L2188	L2250	L2313	L2375	L2438	L2500	L2563	L2625	L2688	L2750	L2813	L2875	L2938	L3000
mm		1563	1625	1688	1750	1813	1875	1938	2000	2063	2125	2188	2250	2313	2375	2438	2500	2563	2625	2688	2750	2813	2875	2938	3000
in		5' 1.5"	5' 4"	5' 6.5"	5' 8.9"	5' 11.4"	6' 1.8"	6' 4.3"	6' 6.7"	6' 9.2"	6' 11.7"	7' 2.1"	7' 0.6"	7' 7.1"	7' 9.5"	7' 12"	8' 2.4"	8' 4.9"	8' 7.3"	8' 9.8"	9' 0.3"	9' 2.7"	9' 5.2"	9' 7.7"	9' 10.1"

For 100 mm (3.93")

LED strip cutting increment		L0100	L0300	L0400	L0500	L0600	L0700	L0800	L0900	L1000	L1100	L1200	L1300	L1400	L1500	L1600	L1700	L1800	L1900	L2000	L2100	L2200	L2300	L2400	L2500
mm		100	300	400	500	600	700	800	900	1000	1100	1200	1300	1400	1500	1600	1700	1800	1900	2000	2100	2200	2300	2400	2500
in		3.9"	11.8"	1' 3.7"	1' 7.7"	1' 11.6"	2' 3.6"	2' 7.5"	2' 11.4"	3' 3.4"	3' 7.3"	3' 11.2"	4' 3.2"	4' 7.1"	4' 11"	5' 3"	5' 6.9"	5' 10.9"	6' 2.8"	6' 6.7"	6' 10.7"	7' 2.6"	7' 6.4"	7' 10.5"	8' 2.4"

mm		L2600	L2700	L2800	L2900	L3000
mm		2600	2700	2800	2900	3000
in		8' 6.4"	8' 10.3"	9' 2.2"	9' 6.2"	9' 10.1"

For 125 mm (4.92")

LED strip cutting increment		L0125	L0250	L0375	L0500	L0625	L0750	L0875	L1000	L1125	L1250	L1375	L1500	L1625	L1750	L1875	L2000	L2125	L2250	L2375	L2500	L2625	L2750	L2875	L3000
mm		125	250	375	500	625	750	875	1000	1125	1250	1375	1500	1625	1750	1875	2000	2125	2250	2375	2500	2625	2750	2875	3000
in		4.9"	9.8"	1' 2.8"	1' 7.7"	2' 0.6"	2' 5.5"	2' 10.4"	3' 3.4"	3' 8.3"	4' 1.2"	4' 6.1"	4' 11.1"	5' 4"	5' 8.9"	6' 1.8"	6' 6.7"	6' 11.7"	7' 4.6"	7' 9.5"	8' 2.4"	8' 7.3"	9' 0.3"	9' 5.2"	9' 10.1"

Module length = **LED Strip Length + Offset**

Offsets:

- Start module: 5 mm (0.2 in)
- Middle module: 2 mm (0.08 in)
- End module: 5 mm (0.2 in)
- Individual, end cable exit: 12 mm (0.47 in)
- Individual, side or back cable exit: 8 mm (0.31 in)
- Full end cable exit: 16 mm (0.63 in)
- Full side or back cable exit: 8 mm (0.31 in)

i.e. Start module length for L2000 LED strip is:

Start module length = 2000mm + 5mm

Note: Length tolerance ± 3mm/m (0.11 in)

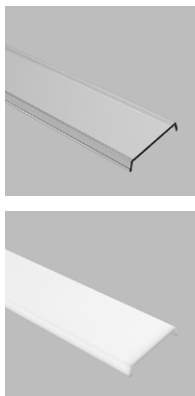

COVERS

CODE	DESCRIPTION
PRG.A016X.C03.CLR	 <p>Clear</p>
PRG.A016X.C03.OPL	 <p>Opal</p>

ACCESSORIES

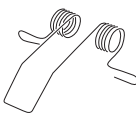
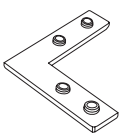
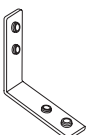
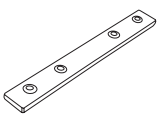
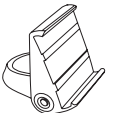
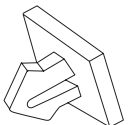
CODE	DESCRIPTION
PRG.A019X.F01.GZK	 <p>Metal spring</p>
PRG.A017X.PRT.03	 <p>Metal holder</p>
PRG.A017X.PRT.02	 <p>Metal holder</p>
PRG.A017X.PRT.01	 <p>Metal holder</p>
PRG.A017X.F02.RGY	 <p>Adjustable angle holder</p>
PRG.A015X.F04.RWE	 <p>Plastic holder</p>

DIMENSIONS

LUMINAIRE

One cable, two endcaps

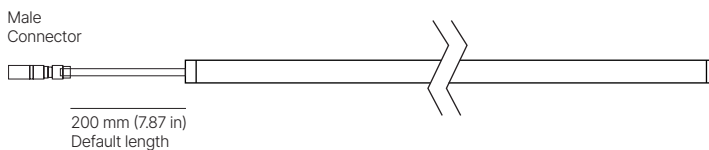

START

Two cables, endcap at the start

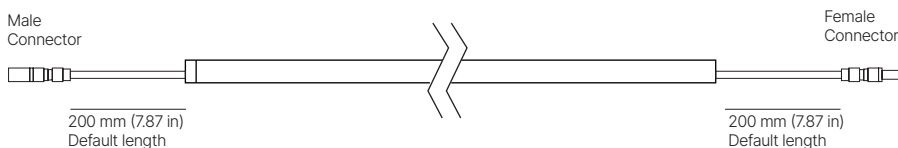

MIDDLE

Two cables, no endcaps

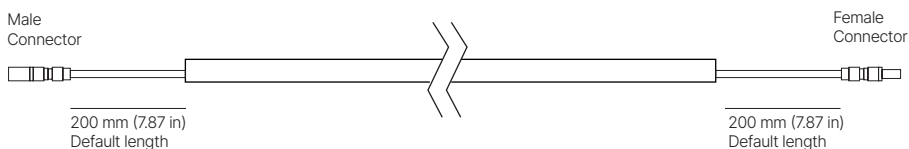

END

One cable, endcap at the end

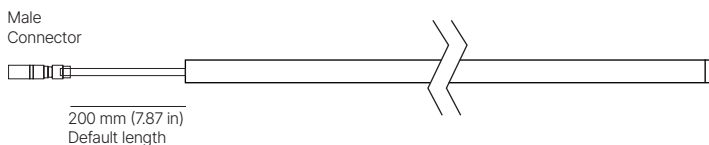

FULL MODULE

Two cables, two endcaps

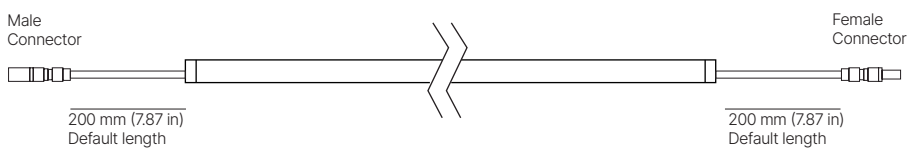

WIRE EXIT

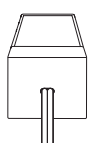

END
Wire comes out from profile through endcap



SIDE
Wire through a hole on the side of the profile



BACK
Wire through a hole on the back of the profile

CONNECTION TYPES

INDIVIDUAL module

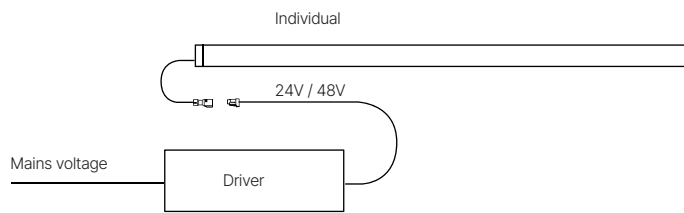

FULL module

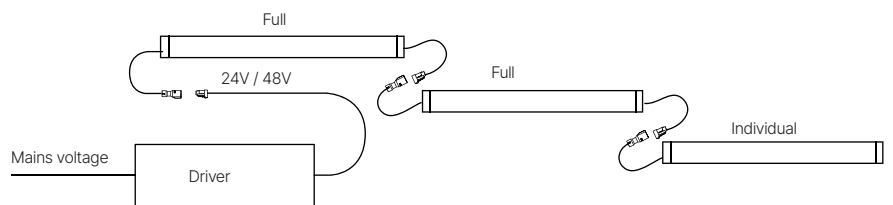

CONTINUOUS LINE module

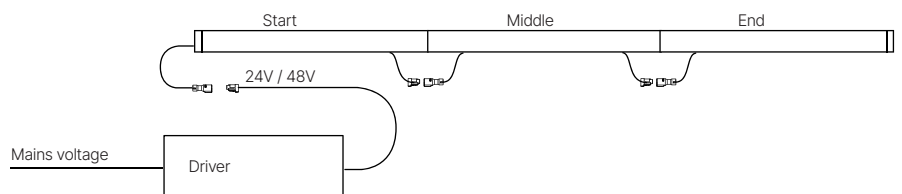

CONNECTORS & WIRES

INDOOR

P1X - MALE CONNECTORS

For white



6,7 mm
(0.26 in)

For RGB



11,7 mm
(0.46 in)

5 mm
(0.2 in)

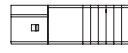

15,5 mm
(0.61 in)

5 mm
(0.2 in)

P1X - FEMALE CONNECTORS



6,1 mm
(0.24 in)



11,1 mm
(0.43 in)

5 mm
(0.2 in)

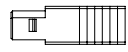

15 mm
(0.59 in)

5 mm
(0.2 in)

WIRES



3,6 mm
(0.14 in)



7,2 mm
(0.28 in)

5 mm
(0.2 in)

WIRE LENGTHS

CODE	L200	L500	L1000	L2000	L3000	L5000	L9000
LENGTH	200mm	500mm	1000mm	2000mm	3000mm	5000mm	9000mm
	7.9"	1' 7.7"	3' 3.4"	5' 6.7"	9' 10.1"	16' 4.9"	29' 6.3"

TECHNICAL SPECIFICATIONS

CERTIFICATIONS



UL approved



Made in Europe



L90B10
60.000 hours



CE compliant



5- year warranty



NICHIA LEDs



KEY BENEFITS



3-step MacAdam LEDs



Stabilized current design



Wide 2000K-6500K white color range



CRI 90 +
CRI 90+tri
CRI 95
Optisolis, RGB



Control sold separately;
DALI, Casambi,
1- 10V, Phase Cut



24V / 48V
voltage input



Customization for your project



Ambient light



Available in any 0.5-3m length



Reverse voltage protection



External driver



Continuous line light effect without dark spots

APPLICATIONS



MAX RUN

Possible max length connected to driver from single side.

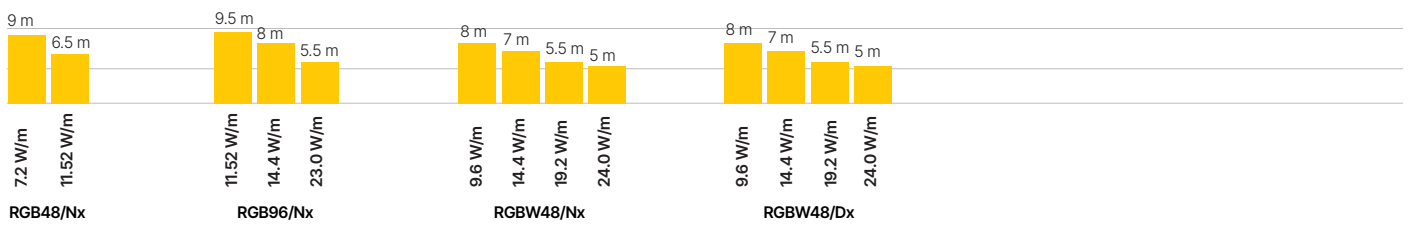
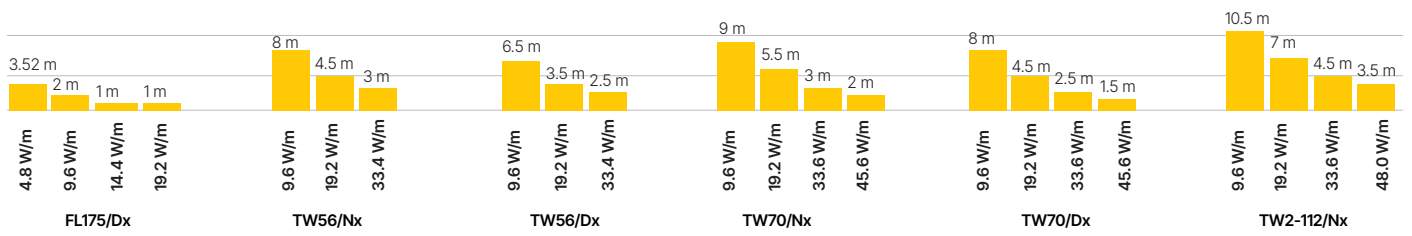
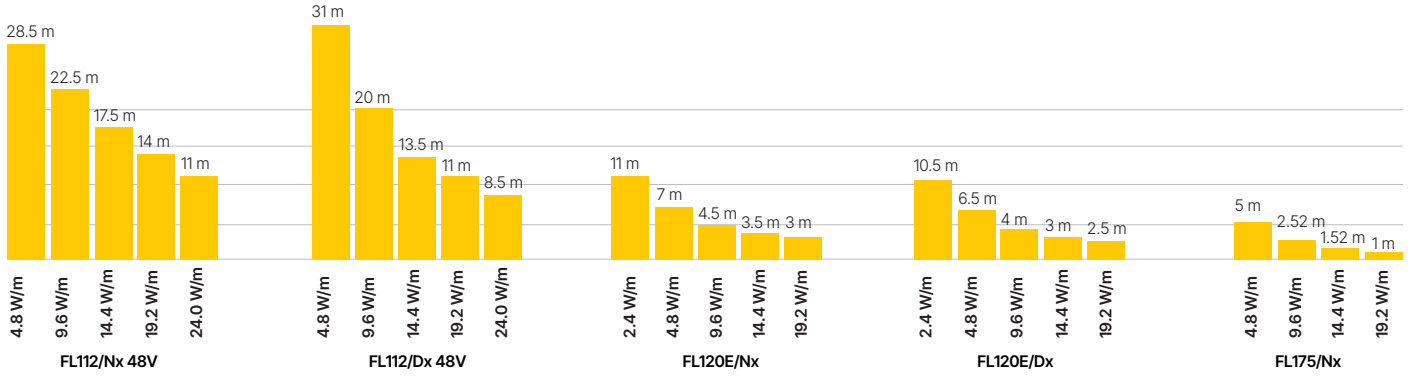
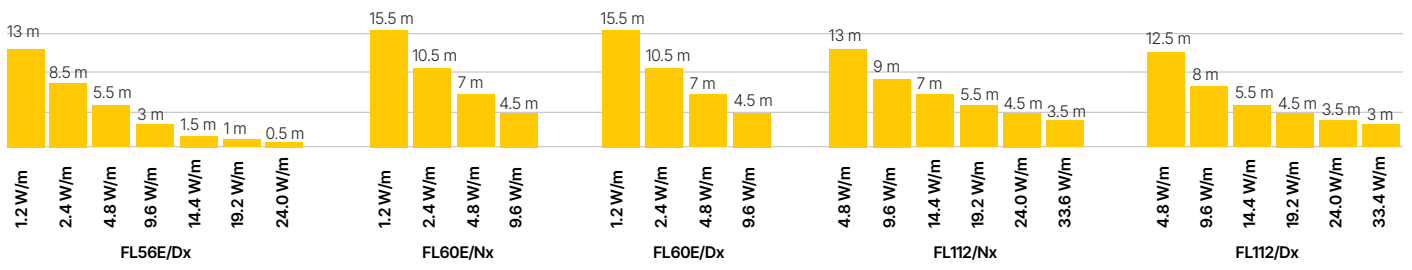
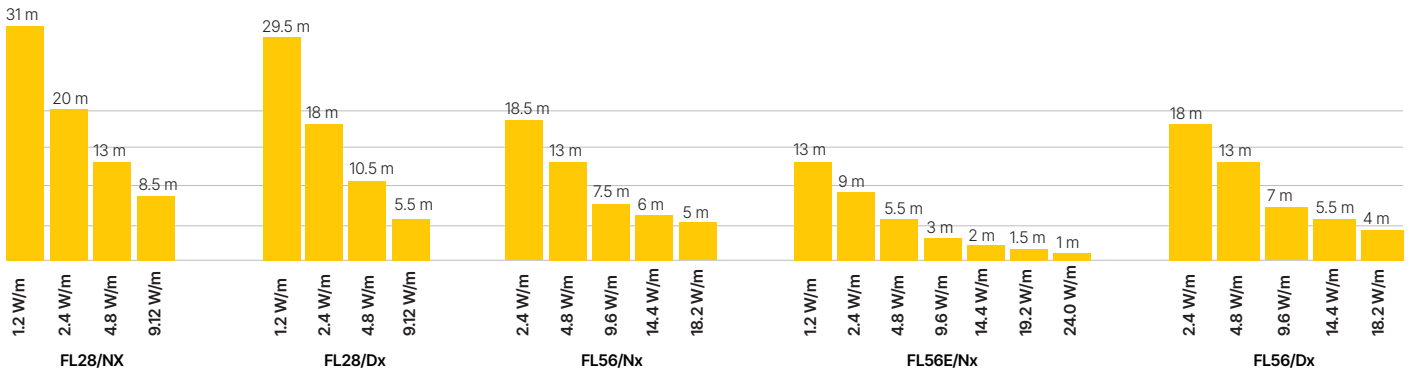



POWER SUPPLY - INDOOR

CODE	DESCRIPTION
<p>DRI.V24.ILS.FO.SE.00001</p> 	<p>FIXED OUTPUT 100W 120 VAC(for NA) 220 - 240 VAC (for EU) 5 - year warranty Color: Static White Voltage: 24V DC Control: FO</p> <div style="display: flex; justify-content: space-around;">   </div>

POWER SUPPLY - OUTDOOR

CODE	DESCRIPTION
<p>DRI.V24.OCO.FO.TR.00030</p> 	<p>FIXED OUTPUT 96W 24V 90 - 305 VAC 5 - year warranty Color: Static White Voltage: 24V DC Control: FO</p> <div style="display: flex; justify-content: space-around;">   </div>

<p>DRI.V24.OCO.DA.MW.00003</p> 	<p>DALI 120W 24V 100 - 240 VAC 5 - year warranty Color: Static White Voltage: 24V DC Control: DA</p> <div style="display: flex; justify-content: space-around;">   </div>
---	---

<p>DRI.V24.OCO.FO.MW.00038</p> 	<p>0-10V 96W 24V 100 - 240 VAC MeanWell CV+CC driver 5 - year warranty Color: Static White Voltage: 24V DC PWM, Resistance Dimming: 0-10V 199×63×35.5mm</p> <div style="display: flex; justify-content: space-around;">   </div>
---	---

MAX PRODUCT LENGTH

WHITE 24V

0.5mm2 (AWG 20)	4.8W/m (1.5W/ft)	9.6W/m (2.9W/ft)	14.4W/m (4.4W/ft)	19.2W/m (5.9W/ft)	24W/m (7.3W/ft)	33.6W/m (10.2W/ft)
Max cable length between luminaire and driver	Product max run					
1 m	12.5 m	8 m	6 m	4.5 m	4 m	3.5 m
2 m	12 m	7.5 m	5.5 m	4 m	3.5 m	3 m
3 m	11.5 m	7.5 m	5.5 m	4 m	3.5 m	2.5 m
5 m	11 m	7 m	5 m	3.5 m	3 m	2 m
10 m	8.5 m	5 m	4 m	2.5 m	2 m	1 m

1.5mm2 (AWG 16)

0.5mm2 (AWG 20)	4.8W/m (1.5W/ft)	9.6W/m (2.9W/ft)	14.4W/m (4.4W/ft)	19.2W/m (5.9W/ft)	24W/m (7.3W/ft)	33.6W/m (10.2W/ft)
Max cable length between luminaire and driver	Product max run					
1 m	12.5 m	8.5 m	6 m	4.5 m	4 m	3.5 m
2 m	12.5 m	8.5 m	6 m	4.5 m	4 m	3.5 m
3 m	12.5 m	8 m	6 m	4.5 m	4 m	3 m
5 m	12 m	8 m	5.5 m	4 m	3.5 m	3 m
10 m	11.5 m	7.5 m	5 m	3.5 m	3.5 m	2.5 m

WHITE 48V

0.5mm2 (AWG 20)	4.8W/m (1.5W/ft)	9.6W/m (2.9W/ft)	14.4W/m (4.4W/ft)	19.2W/m (5.9W/ft)	24W/m (7.3W/ft)
Max cable length between luminaire and driver	Product max run				
1 m	28 m	22 m	17 m	13 m	10.5 m
2 m	27.5 m	21.5 m	16.5 m	12.5 m	10 m
3 m	27 m	21 m	16 m	12 m	9.5 m
5 m	26.5 m	20.5 m	15 m	11 m	8.5 m
10 m	25 m	19 m	13.5 m	9 m	6.5 m

1.5mm2 (AWG 16)

0.5mm2 (AWG 20)	4.8W/m (1.5W/ft)	9.6W/m (2.9W/ft)	14.4W/m (4.4W/ft)	19.2W/m (5.9W/ft)	24W/m (7.3W/ft)
Max cable length between luminaire and driver	Product max run				
1 m	28.5 m	22 m	17 m	13.5 m	10.5 m
2 m	28 m	21.5 m	16.5 m	13 m	10 m
3 m	27.5 m	21.5 m	16.5 m	13 m	10 m
5 m	27.5 m	21 m	16 m	12.5 m	9.5 m
10 m	27 m	20.5 m	15.5 m	12 m	9 m

24V TW 56 N5

0.5mm2 (AWG 20)	9.6W/m (2.9W/ft)	19.2W/m (5.9W/ft)	33.6W/m (10.2W/ft)
Max cable length between luminaire and driver	Product max run		
1 m	7.5 m	4.5 m	2.5 m
2 m	7 m	4 m	2.5 m
3 m	7 m	4 m	2.5 m
5 m	6.5 m	4 m	2.5 m
10 m	5.5 m	3.5 m	2 m

1.5mm2 (AWG 16)

0.5mm2 (AWG 20)	9.6W/m (2.9W/ft)	19.2W/m (5.9W/ft)	33.6W/m (10.2W/ft)
Max cable length between luminaire and driver	Product max run		
1 m	7.5 m	4.5 m	2.5 m
2 m	7.5 m	4 m	2.5 m
3 m	7.5 m	4 m	2.5 m
5 m	7.5 m	4 m	2.5 m
10 m	7 m	4 m	2.5 m

24V TW 70 N5

0.5mm2 (AWG 20)	9.6W/m (2.9W/ft)	19.2W/m (5.9W/ft)	33.6W/m (10.2W/ft)	45.6W/m (14.6W/ft)
Max cable length between luminaire and driver	Product max run			
1 m	7.5 m	4.5 m	2.5 m	1.5 m
2 m	7.5 m	4 m	2.5 m	1.5 m
3 m	7.5 m	4 m	2.5 m	1.5 m
5 m	7 m	4 m	2 m	1.5 m
10 m	6.5 m	3.5 m	1.5 m	1 m

1.5mm2 (AWG 16)

0.5mm2 (AWG 20)	9.6W/m (2.9W/ft)	19.2W/m (5.9W/ft)	33.6W/m (10.2W/ft)	45.6W/m (14.6W/ft)
Max cable length between luminaire and driver	Product max run			
1 m	7.5 m	4.5 m	2.5 m	1.5 m
2 m	7.5 m	4 m	2.5 m	1.5 m
3 m	7.5 m	4 m	2.5 m	1.5 m
5 m	7.5 m	4 m	2.5 m	1.5 m
10 m	7.5 m	4 m	2 m	1.5 m

MAX PRODUCT LENGTH

24V TW2 112

0.5mm ² (AWG 20)	9.6W/m (2.9W/ft)	19.2W/m (5.9W/ft)	33.6W/m (10.2W/ft)	48W/m (14.6W/ft)
Max cable length between luminaire and driver	Product max run			
1 m	8 m	8 m	3 m	2.5 m
2 m	7.5 m	7.5 m	3 m	2.5 m
3 m	7.5 m	7.5 m	3 m	2 m
5 m	7 m	7 m	2.5 m	2 m
10 m	5.5 m	5.5 m	2 m	1.5 m

1.5mm² (AWG 16)

Max cable length between luminaire and driver	Product max run			
1 m	8 m	5 m	3 m	2.5 m
2 m	8 m	5 m	3 m	2.5 m
3 m	8 m	5 m	3 m	2.5 m
5 m	8 m	5 m	3 m	2.5 m
10 m	7.5 m	4.5 m	2.5 m	2 m

24V 48 RGB

0.5mm ² (AWG 20)	7.2W/m (2.2W/ft)	11.5W/m (1.5W/ft)
Max cable length between luminaire and driver	Product max run	
1 m	8.5 m	5.5 m
2 m	8 m	5.5 m
3 m	8 m	5 m
5 m	7.5 m	4.5 m
10 m	7 m	3.5 m

1.5mm² (AWG 16)

Max cable length between luminaire and driver	Product max run	
1 m	8.5 m	5.5 m
2 m	8.5 m	5.5 m
3 m	8.5 m	5.5 m
5 m	8.5 m	5.5 m
10 m	8 m	5 m

24V 96 RGB

0.5mm ² (AWG 20)	11.5W/m (1.5W/ft)	14.4W/m (4.4W/ft)	23W/m (4.4W/ft)
Max cable length between luminaire and driver	Product max run		
1 m	9 m	7.5 m	4.5 m
2 m	8.5 m	7 m	4 m
3 m	8.5 m	7 m	3.5 m
5 m	8 m	6 m	2.5 m
10 m	5.5 m	3.5 m	0

1.5mm² (AWG 16)

Max cable length between luminaire and driver	Product max run		
1 m	9 m	7.5 m	4.5 m
2 m	9 m	7.5 m	4.5 m
3 m	9 m	7.5 m	4.5 m
5 m	8.5 m	7 m	4 m
10 m	8 m	6.5 m	3.5 m

INSTALLATION GUIDES

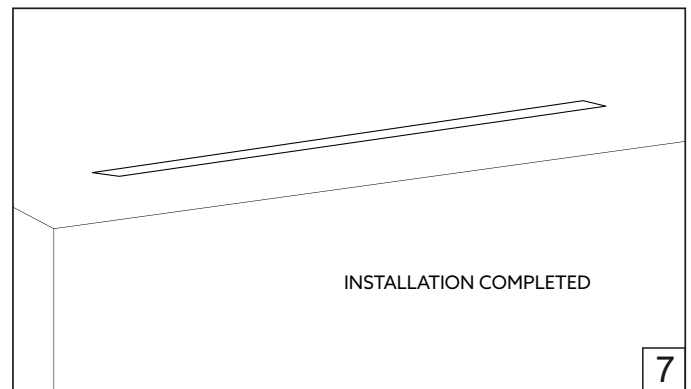
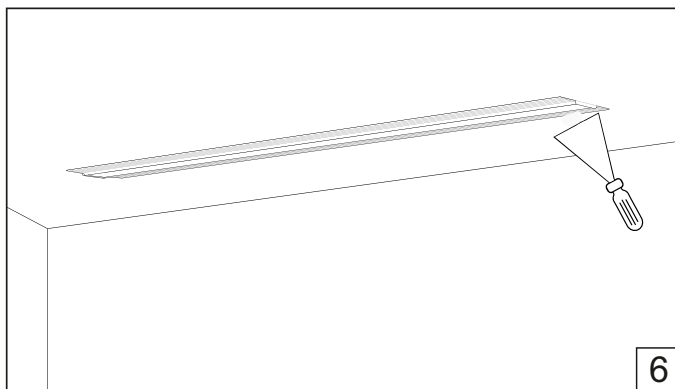
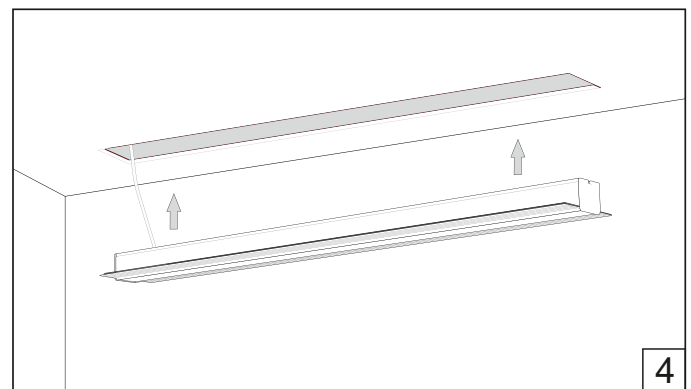
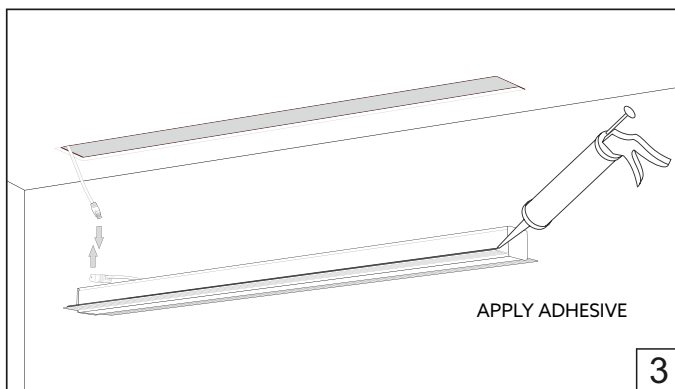
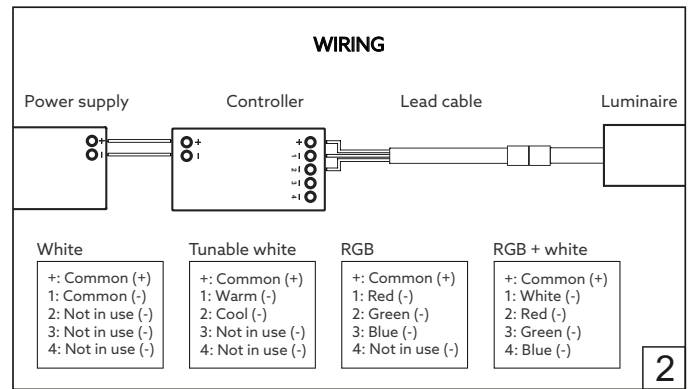
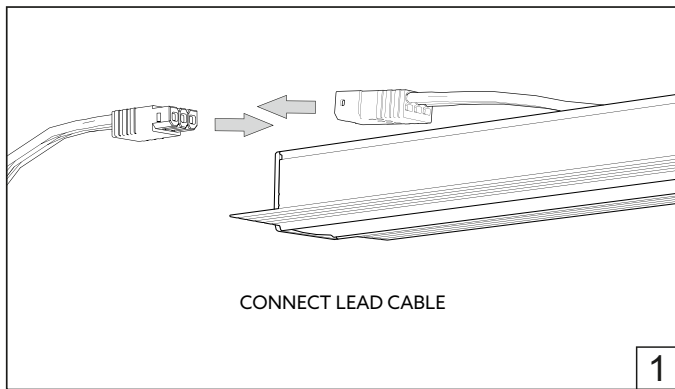

SAFETY / WARNINGS / DISCLOSURES

1. Install in accordance with national and local electrical code regulations.
2. Do not modify or disassemble this product beyond instructions or the warranty will be void.
3. Our channels, covers, end caps, and mounting brackets are also suitable for outdoor use with some considerations. Please consult with local Holecron representative to pick right fixtures for outdoor use.
4. Indoor (IP20) fixtures should never be mounted in areas receiving direct sunlight and locations where they can be submerged under water or might get in direct contact with water or puddling (rainfall, sprinkler, spray, etc.).
5. Avoid leaving gaps in any of the end cap or cover mating edges to the channel that will allow excess dust, debris, or water/moisture to enter the channel enclosure.
6. Actual product color may vary from what is pictured on this sheet and other print materials due to the limitations of photographic processes.
7. We reserve the right to modify and improve the design of our fixtures without prior notice. We cannot guarantee to match existing installed fixtures for subsequent orders or replacements in regards to product appearance, CCT, or lumen output.

SAFETY / WARNINGS / DISCLOSURES

Limited Warranty

This product has a five (5) year limited warranty from the date of shipment. This warranty does not include the additional accessories referenced in this specification sheet. Complete warranty details for fixtures and additional accessories are available online [download here](#). For warranty related questions please contact product support.

CONSUMER'S ACKNOWLEDGMENT

Holecron stands behind its products when they are used properly and according to our specifications. By purchasing our products, the purchaser agrees and acknowledges that lighting design, configuration and installation is a complex process, wherein seemingly minor factors or changes in layout and infield adjustments can have a significant impact on an entire system. Choosing the correct components is essential. Holecron is able to work with the original purchaser to make an appropriate product selection to the extent of the limited information that the customer can provide, but it is virtually impossible for Holecron to design a system that foresees every unknown factor. For this reason, this Warranty does not cover problems caused by improper design, configuration or installation issues.

Any statement from a Holecron employee or agent regarding a customer's bill of goods and/or purchase order is NOT an acknowledgment that the products

purchased are designed and configured correctly. The purchase agrees and acknowledges that it is the customer's responsibility to adhere strictly to all information contained in the Product Specification Sheets. There is often more than one way to design, configure and layout an LED lighting application properly to achieve the same lighting effect. Holecron strongly recommends that licensed professionals be used in the design and installation of lighting systems that include Holecron products. The specifications include important information that a designer and installer should carefully review and strictly follow. Qualified designers and certified and/or licensed installers, with access to the final installation environment, customer goals, and Holecron product specifications can make the requisite decisions appropriate for a successful finished lighting application.

HOLECTRON

HOLECTRON. All rights reserved.
Specifications are subject to change without notice.
Phone: +370 612 42446
email: info@holecron.com | www.holecron.com