

# A002M - Outline

HOLECTRON

## Specification Sheet

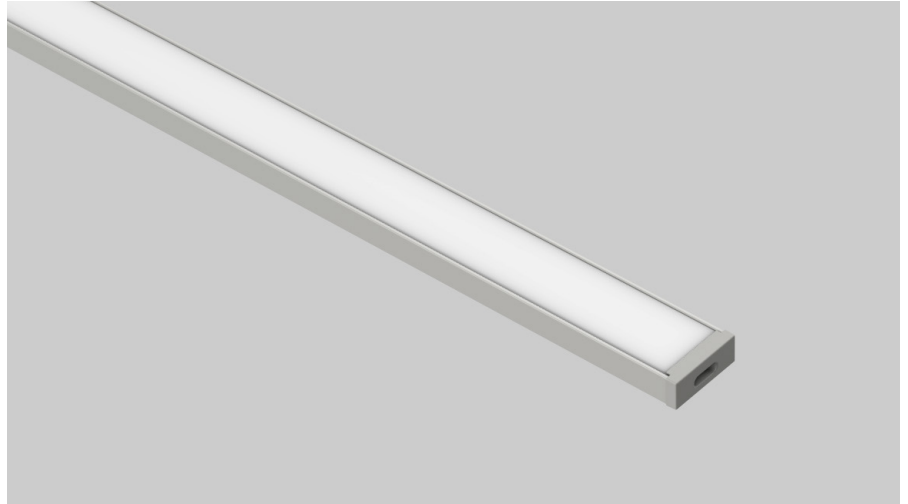

**Area:** Indoor Luminaires



**Category:** Linear lighting / decorative lighting / Cove



**Mounting:** Surface horizontal mounting / Surface vertical mounting / Wall mounting

A002M fixture is a simple yet perfect solution for any cove lighting application.

Take advantage of widest CCT range or customize A002M with Tunable white, RGB, RGBW LED strip and create stunning indirect lighting projects.

Fixtures can be linked up to 14m (46') depending on the output.

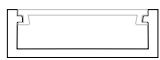

16 mm (0.629 in)

6 mm (0.236 in)

## TECHNICAL DATA

<b>Voltage</b>	24 V / 48 V
<b>LED lumen maintenance</b>	L90B10 > 60.000 h
<b>Light engine</b>	Any LED strip up to 19 W/m
<b>Control</b>	Dimmable



PROJECT
DATE
QUANTITY
NOTES

**ORDER CODE**

NAME	SEGMENT TYPE	HOUSING COLOR	COVER	LUMINAIRE LENGTH	LED SOURCE	POWER	CRI 1	CCT 1
FXL.A002M							T9	
CRI 2	CCT 2 (only for TW strip)	STRIP LENGTH	CABLE TYPE	CONNECTOR	CABLE LENGTH	STANDART NAME	PACKING	
T9			HR			STD	PH	

SEGMENT TYPE	<b>I</b> individual luminaire, 2 end caps	<b>S</b> start segment, back wire exit, 1 end cap	<b>M</b> middle segment, back wire exit, no end caps	<b>E</b> end segment, back wire exit, 1 end cap	<b>F</b> full module, 2 end cap
--------------	---	--	---	--	---------------------------------------

WIRE EXIT	<b>B</b> back	<b>E</b> end
-----------	------------------	-----------------

HOUSING COLOR	<b>AGY</b> anodized gray	<b>PWE</b> white	<b>PBK</b> black	<b>PGY</b> gray	<b>CUSTOM</b> contact sales
---------------	-----------------------------	---------------------	---------------------	--------------------	--------------------------------

COVER	<b>LSI.1.CLR</b> clear LOR 92%*	<b>LSI.1.OPL</b> opal LOR 74%* homogenous
-------	---------------------------------------	--

LED SOURCE	<b>FL112/NX</b> static white 62.5 mm (2.46")	<b>TW70/NN</b> tunable white 100mm (3.93")	<b>RGB96/NX</b> RGB 62.5 mm (2.46")	<b>RGBW48/NN</b> RGBW 125 mm (4.92")
POWER	<b>4W</b> 4,8 W/m 1.5 W/ft 737 Lm/m (225 Lm/ft)	<b>9W</b> 9,6 W/m 2.9 W/ft 1469 Lm/m (448 Lm/ft)	<b>11W</b> 11,52 W/m 3.5 W/ft 479 Lm/m (146 Lm/ft)	<b>9W</b> 4,8 W/m 1.5 W/ft 608 Lm/m (185 Lm/ft)
	<b>9W</b> 9,6 W/m 2.9 W/ft 1460 Lm/m (445 lm/ft)	<b>19W</b> 19,2 W/m 5.8 W/ft 2900 Lm/m (884 Lm/ft)	<b>14W</b> 9,6 W/m 2.9 W/ft 600 Lm/m (183Lm/ft)	<b>14W</b> 9,6 W/m 2.9 W/ft 886 Lm/m (270 Lm/ft)
	<b>14W</b> 14,4 W/m 4.4 W/ft 2170 Lm/m (662 lm/ft)			<b>19W</b> 14,4 W/m 4.4 W/ft 1392 Lm/m (424 Lm/ft)
	<b>19W</b> 19,2 W/m 5.8 W/ft 2868 Lm/m (874 lm/ft)			
CCT 1	<b>18 / 20 / 22 / 25 / 27 / 30 / 35 / 40 / 50 / 57 / 65</b> 1800K / 2000K / 2200K / 2500K / 2700K / 3000K / 3500K / 4000K / 5000K / 5700K / 6500K	<b>27-65</b> 2700K - 6500K		<b>18 / 20 / 22 / 25 / 27 / 30 / 35 / 40 / 50 / 57 / 65</b> 1800K / 2000K / 2200K / 2500K / 2700K / 3000K / 3500K / 4000K / 5000K / 5700K / 6500K

CONNECTOR	<b>NON</b> no connectors	<b>P1X</b> connector P1X
-----------	-----------------------------	-----------------------------

CABLE LENGTH	<b>L200</b> 200 mm 7.9" Default	<b>L500</b> 500 mm 1' 7.7"	<b>L1000</b> 1000 mm 3' 3.4"	<b>L2000</b> 2000 mm 5' 6.7"	<b>L3000</b> 3000 mm 9' 10.1"	<b>L5000</b> 5000 mm 16' 4.9"	<b>L9000</b> 9000 mm 29' 6.3"
--------------	--	----------------------------------	------------------------------------	------------------------------------	-------------------------------------	-------------------------------------	-------------------------------------

Lumen values is from bare LED strip. When assembled in profile, lumen value must be multiplied by LOR percentage to retrieve actual lumen value of assembled solution

\*The LOR was calculated using a white profile. The values may vary when using profiles of other colors.

CCT	1800K	2000K	2200K	2500K	2700K	3000K	3500K	4000K	5000K	5700K	6500K
MULTIPLIER NICHIA	0.54	0.58	0.63	0.68	0.95	1.00	1.02	1.04	1.04	1.01	1.01

**LED STRIP LENGTH**

For 62.5mm (2.46")

LED strip cutting increment		L0063	L0125	L0188	L0250	L0313	L0375	L0438	L0500	L563	L0625	L0688	L0750	L0813	L0875	L0938	L1000	L1063	L1125	L1188	L1250	L1313	L1375	L1438	L1500
mm		63	125	188	250	313	375	438	500	563	625	688	750	813	875	938	1000	1063	1125	1188	1250	1313	1375	1438	1500
in		2.5"	4.9"	7.4"	9.8"	1' 0.3"	1' 2.8"	1' 5.2"	1' 7.7"	1' 10.2"	2' 0.6"	2' 3.1"	2' 5.5"	2' 8"	2' 10.4"	3' 0.9"	3' 3.4"	3' 5.9"	3' 8.3"	3' 10.8"	4' 1.2"	4' 3.7"	4' 6.1"	4' 8.6"	4' 11"

mm	L1563	L1625	L1688	L1750	L1813	L1875	L1938	L2000	L2063	L2125	L2188	L2250	L2313	L2375	L2438	L2500	L2563	L2625	L2688	L2750	L2813	L2875	L2938	L3000
	1563	1625	1688	1750	1813	1875	1938	2000	2063	2125	2188	2250	2313	2375	2438	2500	2563	2625	2688	2750	2813	2875	2938	3000
in	5' 1.5"	5' 4"	5' 6.5"	5' 8.9"	5' 11.4"	6' 1.8"	6' 4.3"	6' 6.7"	6' 9.2"	6' 11.7"	7' 2.1"	7' 0.6"	7' 7.1"	7' 9.5"	7' 12"	8' 2.4"	8' 4.9"	8' 7.3"	8' 9.8"	9' 0.3"	9' 2.7"	9' 5.2"	9' 7.7"	9' 10.1"

For 100 mm (3.93")

LED strip cutting increment		L0100	L0300	L0400	L0500	L0600	L0700	L0800	L0900	L1000	L1100	L1200	L1300	L1400	L1500	L1600	L1700	L1800	L1900	L2000	L2100	L2200	L2300	L2400	L2500
mm		100	300	400	500	600	700	800	900	1000	1100	1200	1300	1400	1500	1600	1700	1800	1900	2000	2100	2200	2300	2400	2500
in		3.9"	11.8"	1' 3.7"	1' 7.7"	1' 11.6"	2' 3.6"	2' 7.5"	2' 11.4"	3' 3.4"	3' 7.3"	3' 11.2"	4' 3.2"	4' 7.1"	4' 11"	5' 3"	5' 6.9"	5' 10.9"	6' 2.8"	6' 6.7"	6' 10.7"	7' 2.6"	7' 6.4"	7' 10.5"	8' 2.4"

mm	L2600	L2700	L2800	L2900	L3000
	2600	2700	2800	2900	3000
in	8' 6.4"	8' 10.3"	9' 2.2"	9' 6.2"	9' 10.1"

For 125 mm (4.92")

LED strip cutting increment		L0125	L0250	L0375	L0500	L0625	L0750	L0875	L1000	L1125	L1250	L1375	L1500	L1625	L1750	L1875	L2000	L2125	L2250	L2375	L2500	L2625	L2750	L2875	L3000
mm		125	250	375	500	625	750	875	1000	1125	1250	1375	1500	1625	1750	1875	2000	2125	2250	2375	2500	2625	2750	2875	3000
in		4.9"	9.8"	1' 2.8"	1' 7.7"	2' 0.6"	2' 5.5"	2' 10.4"	3' 3.4"	3' 8.3"	4' 1.2"	4' 6.1"	4' 11.1"	5' 4"	5' 8.9"	6' 1.8"	6' 6.7"	6' 11.7"	7' 4.6"	7' 9.5"	8' 2.4"	8' 7.3"	9' 0.3"	9' 5.2"	9' 10.1"

Module length = LED Strip Length + Offset

Offsets:

- Start module: 6 mm (0.23 in)
- Middle module: 2 mm (0.08 in)
- End module: 6 mm (0.23 in)
- Individual module: 10 mm (0.39 in)
- Full module: 10 mm (0.39 in)

i.e. Start module length for L2000 LED strip is:

Start module length = 2000mm + 6mm

**Note:** Length tolerance ± 3mm/m (0.11 in)

---

**COVERS**

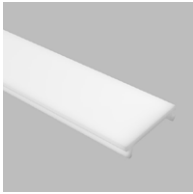

CODE	DESCRIPTION
PRG.AULSI.CO.CLR	Clear
PRG.AULSI.CO.OPL	Opal

---

**ACCESSORIES**

CODE	DESCRIPTION
PRG.A002X.F08.RGY	Metal
PRG.A002X.F03.GZK	Metal

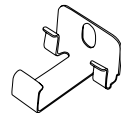
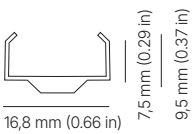

**DIMENSIONS**

**LUMINAIRE**

One cable, two endcaps

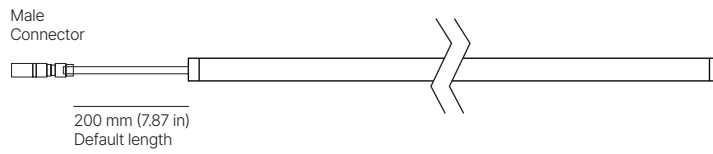

**START**

Two cables, endcap at the start

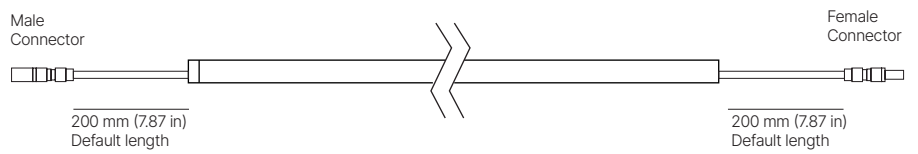

**MIDDLE**

Two cables, no endcaps

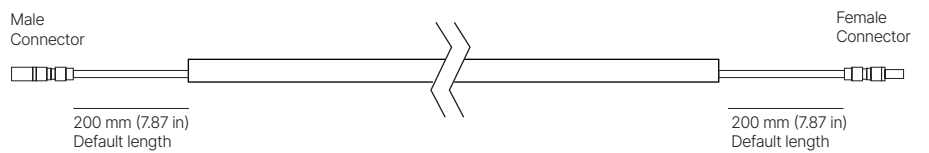

**END**

One cable, endcap at the end



**FULL MODULE**

Two cables, two endcaps

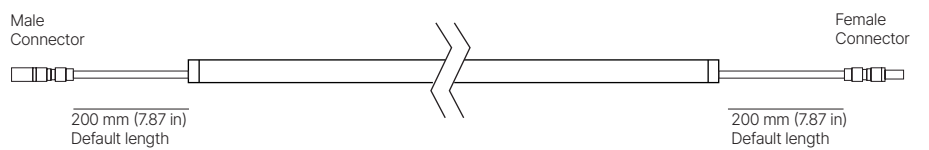

**WIRE EXIT**



**END**

Wire comes out from profile through endcap



**BACK**

Wire through a hole on the back of the profile

---

**CONNECTION TYPES**

**INDIVIDUAL module**

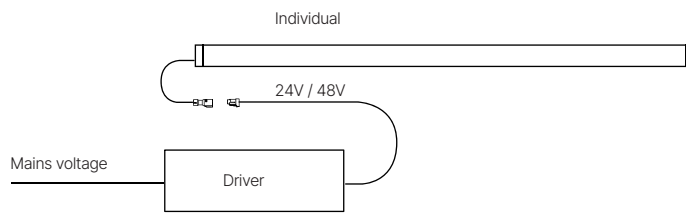

**FULL module**

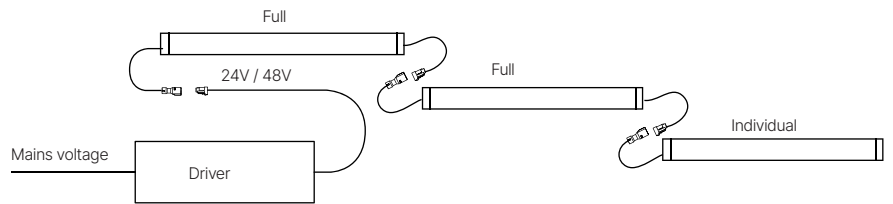

**CONTINUOUS LINE module**

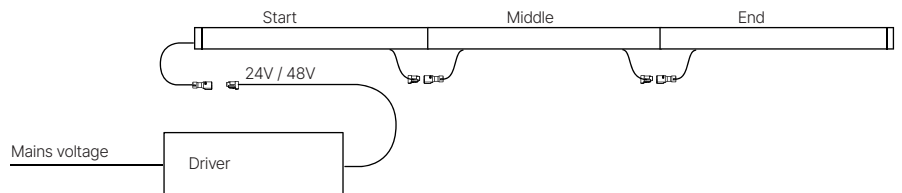

**CONNECTORS & WIRES**

**INDOOR**

**P1X - MALE CONNECTORS**

For white



6,7 mm  
(0.26 in)

For RGB



11,7 mm  
(0.46 in)

5 mm  
(0.2 in)

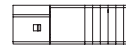

15,5 mm  
(0.61 in)

5 mm  
(0.2 in)

**P1X - FEMALE CONNECTORS**



6,1 mm  
(0.24 in)



11,1 mm  
(0.43 in)

5 mm  
(0.2 in)

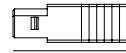

15 mm  
(0.59 in)

5 mm  
(0.2 in)

**WIRES**



3,6 mm  
(0.14 in)



7,2 mm  
(0.28 in)

5 mm  
(0.2 in)

**WIRE LENGTHS**

CODE	L200	L500	L1000	L2000	L3000	L5000	L9000
LENGTH	200mm	500mm	1000mm	2000mm	3000mm	5000mm	9000mm
	7.9"	1' 7.7"	3' 3.4"	5' 6.7"	9' 10.1"	16' 4.9"	29' 6.3"

**TECHNICAL SPECIFICATIONS**

**CERTIFICATIONS**



UL approved



Made in Europe



L90B10  
60.000 hours



CE compliant



5- year warranty



NICHIA LEDs



**KEY BENEFITS**



3-step MacAdam LEDs



Stabilized current design



Wide 2000K-6500K white color range



CRI 90 +  
CRI 90+tri  
CRI 95 +  
Optisolis, RGB



Control sold separately;  
DALI, Casambi,  
1- 10V, Phase Cut



24V / 48V  
voltage input



Customization for your project



Ambient light



Available in any 0.5-3m length



Reverse voltage protection



External driver



Continuous line light effect without dark spots

---

**OPTICS OUTDOOR**

**A002M PWE CLR**  
LOR - 92%

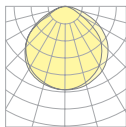

**A002M PBK CLR**  
LOR - 83%

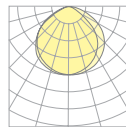

**A002M AGY CLR**  
LOR - 88%

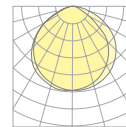

**A002M PWE OPL**  
LOR - 74%

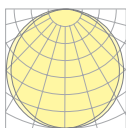

**A002M PBK OPL**  
LOR - 59%

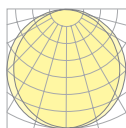

**A002M AGY OPL**  
LOR - 66%

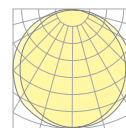

---

**APPLICATIONS**



**MAX RUN**

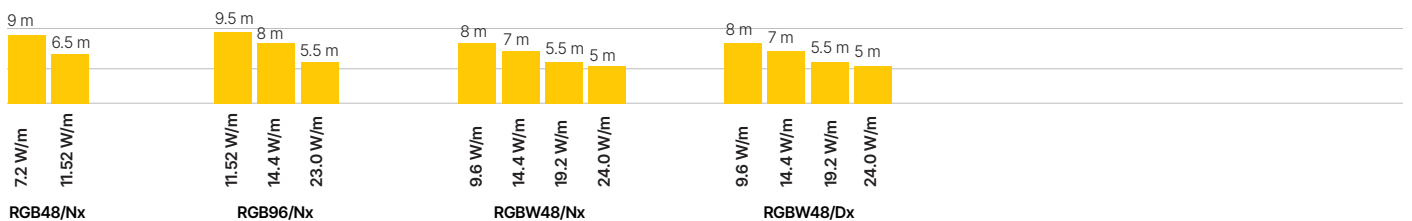
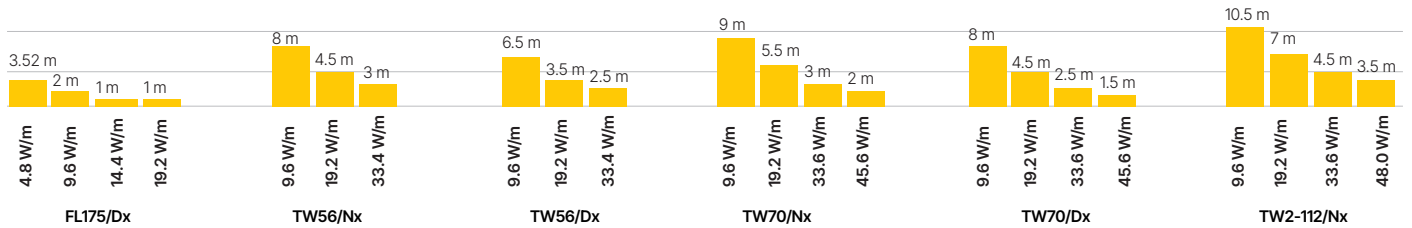
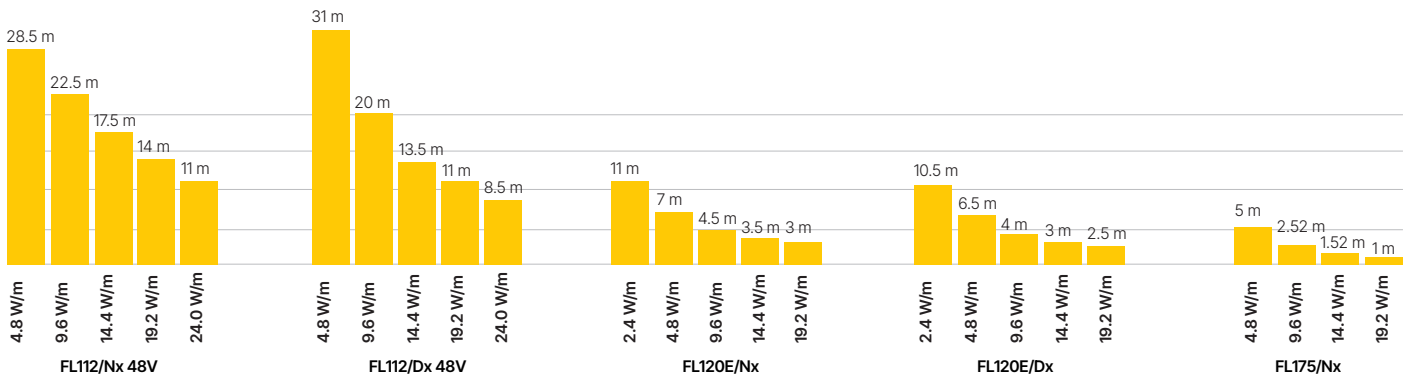
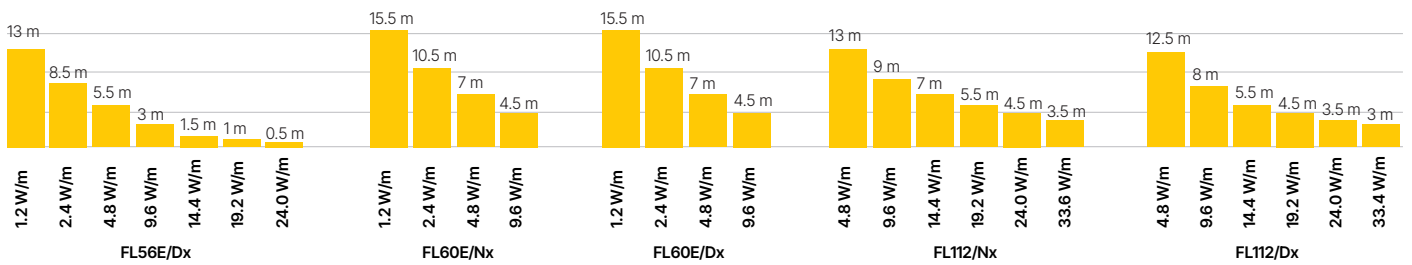
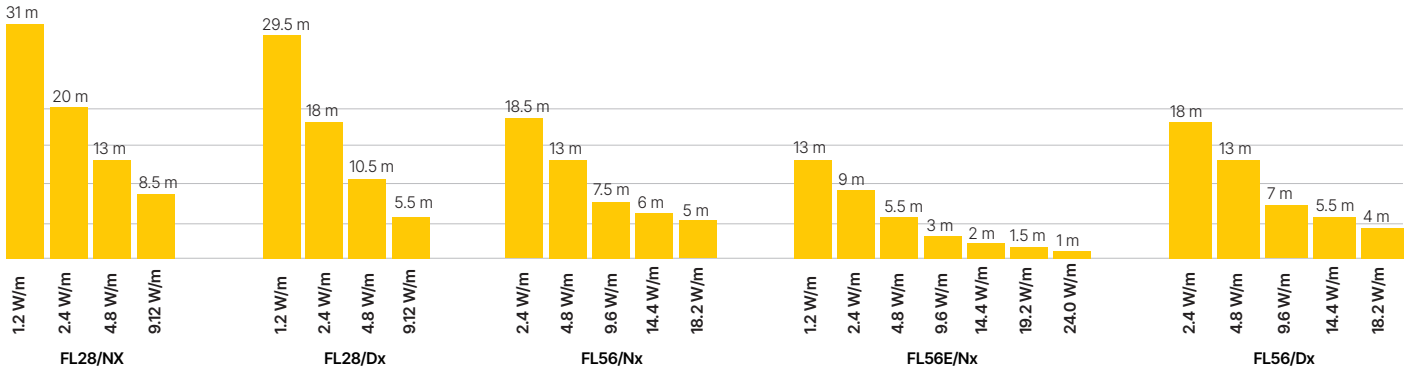

Possible max length connected to driver from single side.





**POWER SUPPLY - INDOOR**

CODE	DESCRIPTION
<p data-bbox="593 302 853 336"><b>DRI.V24.ILS.FO.SE.00001</b></p> 	<p data-bbox="1021 347 1236 380"><b>FIXED OUTPUT</b></p> <p data-bbox="1021 380 1484 504">100W 120 VAC(for NA) 220 - 240 VAC (for EU) 5 - year warranty Color: Static White Voltage: 24V DC Control: FO</p> <div data-bbox="1045 515 1220 593">   </div>

**POWER SUPPLY - OUTDOOR**

CODE	DESCRIPTION
<p data-bbox="593 878 869 911"><b>DRI.V24.OCO.FO.TR.00030</b></p> 	<p data-bbox="1021 934 1236 967"><b>FIXED OUTPUT</b></p> <p data-bbox="1021 967 1484 1097">96W 24V 90 - 305 VAC 5 - year warranty Color: Static White Voltage: 24V DC Control: FO</p> <div data-bbox="1045 1108 1220 1187">   </div>

<p data-bbox="593 1232 885 1265"><b>DRI.V24.OCO.DA.MW.00003</b></p> 	<p data-bbox="1021 1276 1109 1310"><b>DALI</b></p> <p data-bbox="1021 1310 1484 1444">120W 24V 100 - 240 VAC 5 - year warranty Color: Static White Voltage: 24V DC Control: DA</p> <div data-bbox="1045 1456 1220 1534">   </div>
---	---

<p data-bbox="593 1579 885 1612"><b>DRI.V24.OCO.FO.MW.00038</b></p> 	<p data-bbox="1021 1624 1125 1657"><b>0-10V</b></p> <p data-bbox="1021 1657 1484 1870">96W 24V 100 - 240 VAC MeanWell CV+CC driver 5 - year warranty Color: Static White Voltage: 24V DC PWM, Resistance Dimming: 0-10V 199×63×35.5mm</p> <div data-bbox="1045 1881 1220 1960">   </div>
---	--

**MAX PRODUCT LENGTH**

**WHITE 24V**

0.5mm2 (AWG 20)	4.8W/m (1.5W/ft)	9.6W/m (2.9W/ft)	14.4W/m (4.4W/ft)	19.2W/m (5.9W/ft)	24W/m (7.3W/ft)	33.6W/m (10.2W/ft)
Max cable length between luminaire and driver	Product max run					
1 m	12.5 m	8 m	6 m	4.5 m	4 m	3.5 m
2 m	12 m	7.5 m	5.5 m	4 m	3.5 m	3 m
3 m	11.5 m	7.5 m	5.5 m	4 m	3.5 m	2.5 m
5 m	11 m	7 m	5 m	3.5 m	3 m	2 m
10 m	8.5 m	5 m	4 m	2.5 m	2 m	1 m

**1.5mm2 (AWG 16)**

0.5mm2 (AWG 20)	4.8W/m (1.5W/ft)	9.6W/m (2.9W/ft)	14.4W/m (4.4W/ft)	19.2W/m (5.9W/ft)	24W/m (7.3W/ft)	33.6W/m (10.2W/ft)
Max cable length between luminaire and driver	Product max run					
1 m	12.5 m	8.5 m	6 m	4.5 m	4 m	3.5 m
2 m	12.5 m	8.5 m	6 m	4.5 m	4 m	3.5 m
3 m	12.5 m	8 m	6 m	4.5 m	4 m	3 m
5 m	12 m	8 m	5.5 m	4 m	3.5 m	3 m
10 m	11.5 m	7.5 m	5 m	3.5 m	3.5 m	2.5 m

**WHITE 48V**

0.5mm2 (AWG 20)	4.8W/m (1.5W/ft)	9.6W/m (2.9W/ft)	14.4W/m (4.4W/ft)	19.2W/m (5.9W/ft)	24W/m (7.3W/ft)
Max cable length between luminaire and driver	Product max run				
1 m	28 m	22 m	17 m	13 m	10.5 m
2 m	27.5 m	21.5 m	16.5 m	12.5 m	10 m
3 m	27 m	21 m	16 m	12 m	9.5 m
5 m	26.5 m	20.5 m	15 m	11 m	8.5 m
10 m	25 m	19 m	13.5 m	9 m	6.5 m

**1.5mm2 (AWG 16)**

0.5mm2 (AWG 20)	4.8W/m (1.5W/ft)	9.6W/m (2.9W/ft)	14.4W/m (4.4W/ft)	19.2W/m (5.9W/ft)	24W/m (7.3W/ft)
Max cable length between luminaire and driver	Product max run				
1 m	28.5 m	22 m	17 m	13.5 m	10.5 m
2 m	28 m	21.5 m	16.5 m	13 m	10 m
3 m	27.5 m	21.5 m	16.5 m	13 m	10 m
5 m	27.5 m	21 m	16 m	12.5 m	9.5 m
10 m	27 m	20.5 m	15.5 m	12 m	9 m

**24V TW 56 N5**

0.5mm2 (AWG 20)	9.6W/m (2.9W/ft)	19.2W/m (5.9W/ft)	33.6W/m (10.2W/ft)
Max cable length between luminaire and driver	Product max run		
1 m	7.5 m	4.5 m	2.5 m
2 m	7 m	4 m	2.5 m
3 m	7 m	4 m	2.5 m
5 m	6.5 m	4 m	2.5 m
10 m	5.5 m	3.5 m	2 m

**1.5mm2 (AWG 16)**

0.5mm2 (AWG 20)	9.6W/m (2.9W/ft)	19.2W/m (5.9W/ft)	33.6W/m (10.2W/ft)
Max cable length between luminaire and driver	Product max run		
1 m	7.5 m	4.5 m	2.5 m
2 m	7.5 m	4 m	2.5 m
3 m	7.5 m	4 m	2.5 m
5 m	7.5 m	4 m	2.5 m
10 m	7 m	4 m	2.5 m

**24V TW 70 N5**

0.5mm2 (AWG 20)	9.6W/m (2.9W/ft)	19.2W/m (5.9W/ft)	33.6W/m (10.2W/ft)	45.6W/m (14.6W/ft)
Max cable length between luminaire and driver	Product max run			
1 m	7.5 m	4.5 m	2.5 m	1.5 m
2 m	7.5 m	4 m	2.5 m	1.5 m
3 m	7.5 m	4 m	2.5 m	1.5 m
5 m	7 m	4 m	2 m	1.5 m
10 m	6.5 m	3.5 m	1.5 m	1 m

**1.5mm2 (AWG 16)**

0.5mm2 (AWG 20)	9.6W/m (2.9W/ft)	19.2W/m (5.9W/ft)	33.6W/m (10.2W/ft)	45.6W/m (14.6W/ft)
Max cable length between luminaire and driver	Product max run			
1 m	7.5 m	4.5 m	2.5 m	1.5 m
2 m	7.5 m	4 m	2.5 m	1.5 m
3 m	7.5 m	4 m	2.5 m	1.5 m
5 m	7.5 m	4 m	2.5 m	1.5 m
10 m	7.5 m	4 m	2 m	1.5 m

**MAX PRODUCT LENGTH**

**24V TW2 112**

0.5mm2 (AWG 20)	9.6W/m (2.9W/ft)	19.2W/m (5.9W/ft)	33.6W/m (10.2W/ft)	48W/m (14.6W/ft)
Max cable length between luminaire and driver	Product max run			
1 m	8 m	8 m	3 m	2.5 m
2 m	7.5 m	7.5 m	3 m	2.5 m
3 m	7.5 m	7.5 m	3 m	2 m
5 m	7 m	7 m	2.5 m	2 m
10 m	5.5 m	5.5 m	2 m	1.5 m

**1.5mm2 (AWG 16)**

Max cable length between luminaire and driver	Product max run			
1 m	8 m	5 m	3 m	2.5 m
2 m	8 m	5 m	3 m	2.5 m
3 m	8 m	5 m	3 m	2.5 m
5 m	8 m	5 m	3 m	2.5 m
10 m	7.5 m	4.5 m	2.5 m	2 m

**24V 48 RGB**

0.5mm2 (AWG 20)	7.2W/m (2.2W/ft)	11.5W/m (1.5W/ft)
Max cable length between luminaire and driver	Product max run	
1 m	8.5 m	5.5 m
2 m	8 m	5.5 m
3 m	8 m	5 m
5 m	7.5 m	4.5 m
10 m	7 m	3.5 m

**1.5mm2 (AWG 16)**

Max cable length between luminaire and driver	Product max run	
1 m	8.5 m	5.5 m
2 m	8.5 m	5.5 m
3 m	8.5 m	5.5 m
5 m	8.5 m	5.5 m
10 m	8 m	5 m

**24V 96 RGB**

0.5mm2 (AWG 20)	11.5W/m (1.5W/ft)	14.4W/m (4.4W/ft)	23W/m (4.4W/ft)
Max cable length between luminaire and driver	Product max run		
1 m	9 m	7.5 m	4.5 m
2 m	8.5 m	7 m	4 m
3 m	8.5 m	7 m	3.5 m
5 m	8 m	6 m	2.5 m
10 m	5.5 m	3.5 m	0

**1.5mm2 (AWG 16)**

Max cable length between luminaire and driver	Product max run		
1 m	9 m	7.5 m	4.5 m
2 m	9 m	7.5 m	4.5 m
3 m	9 m	7.5 m	4.5 m
5 m	8.5 m	7 m	4 m
10 m	8 m	6.5 m	3.5 m

**INSTALLATION GUIDE**

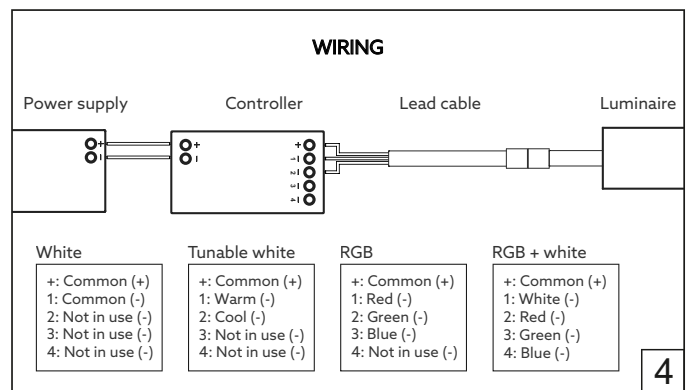
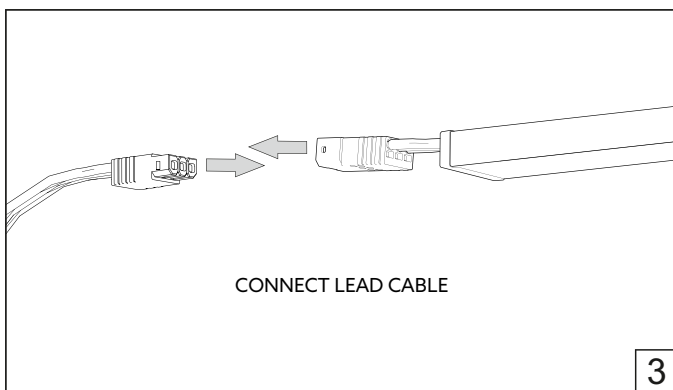
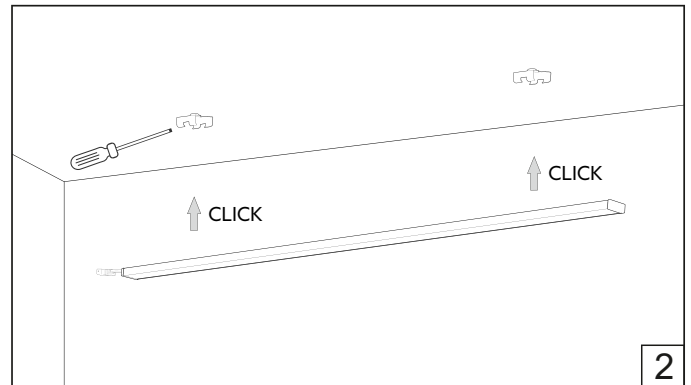
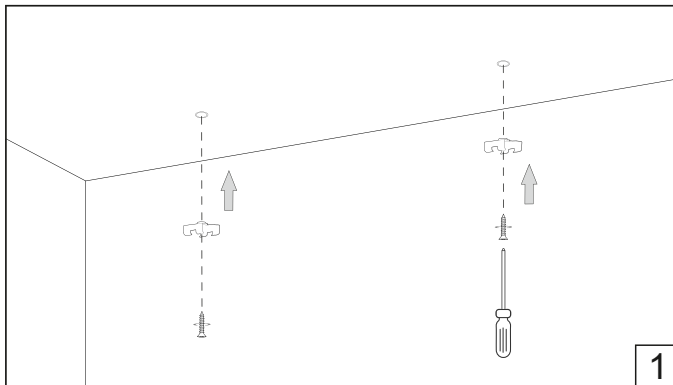

## SAFETY / WARNINGS / DISCLOSURES

1. Install in accordance with national and local electrical code regulations.
2. Do not modify or disassemble this product beyond instructions or the warranty will be void.
3. Our channels, covers, end caps, and mounting brackets are also suitable for outdoor use with some considerations. Please consult with local Holecron representative to pick right fixtures for outdoor use.
4. Indoor (IP20) fixtures should never be mounted in areas receiving direct sunlight and locations where they can be submerged under water or might get in direct contact with water or puddling (rainfall, sprinkler, spray, etc.).
5. Avoid leaving gaps in any of the end cap or cover mating edges to the channel that will allow excess dust, debris, or water/moisture to enter the channel enclosure.
6. Actual product color may vary from what is pictured on this sheet and other print materials due to the limitations of photographic processes.
7. We reserve the right to modify and improve the design of our fixtures without prior notice. We cannot guarantee to match existing installed fixtures for subsequent orders or replacements in regards to product appearance, CCT, or lumen output.

## SAFETY / WARNINGS / DISCLOSURES

### Limited Warranty

This product has a five (5) year limited warranty from the date of shipment. This warranty does not include the additional accessories referenced in this specification sheet. Complete warranty details for fixtures and additional accessories are available online [download here](#). For warranty related questions please contact product support.

## CONSUMER'S ACKNOWLEDGMENT

Holecron stands behind its products when they are used properly and according to our specifications. By purchasing our products, the purchaser agrees and acknowledges that lighting design, configuration and installation is a complex process, wherein seemingly minor factors or changes in layout and infield adjustments can have a significant impact on an entire system. Choosing the correct components is essential. Holecron is able to work with the original purchaser to make an appropriate product selection to the extent of the limited information that the customer can provide, but it is virtually impossible for Holecron to design a system that foresees every unknown factor. For this reason, this Warranty does not cover problems caused by improper design, configuration or installation issues.

Any statement from a Holecron employee or agent regarding a customer's bill of goods and/or purchase order is NOT an acknowledgment that the products

purchased are designed and configured correctly. The purchase agrees and acknowledges that it is the customer's responsibility to adhere strictly to all information contained in the Product Specification Sheets. There is often more than one way to design, configure and layout an LED lighting application properly to achieve the same lighting effect. Holecron strongly recommends that licensed professionals be used in the design and installation of lighting systems that include Holecron products. The specifications include important information that a designer and installer should carefully review and strictly follow. Qualified designers and certified and/or licensed installers, with access to the final installation environment, customer goals, and Holecron product specifications can make the requisite decisions appropriate for a successful finished lighting application.

## HOLECTRON

HOLECTRON. All rights reserved.  
Specifications are subject to change without notice.  
Phone: +370 612 42446  
email: [info@holecron.com](mailto:info@holecron.com) | [www.holecron.com](http://www.holecron.com)